

Removing Covers of Planmeca Equipment

ProMax

Shoulder cover



- The shoulder cover can be detached by lifting up on both the front and back of the cover. The cover is held on by pressure clips and screw posts.

Lower front cover panel



- The lower front cover can be detached by pulling on the inside edge along the bottom of the cover. Since the emergency stop plate bar might be in the way, use an Allen wrench to slip behind the cover and gently pull away from the column to pop it off.

Upper front cover panel



- The upper front cover can be detached easiest by first removing the lower front lower and then by pulling on the bottom left and right tabs until the cover pops off. ****If the cover does not come off with light pulling, it has a locking mechanism. A slotted screw driver must be inserted into the hole found under the patient support arm. There will be a slot near the inner column that the screw driver will fit into and a quarter turn will release the locking mechanism, enabling the cover to be detached.**



EMC shield



- The unit may have an EMC shield under the front cover. It can be detached by removing the six 2mm Allen screws found along the sides. EMC shield for PSU2 on next page.

EMC shield for PSU2

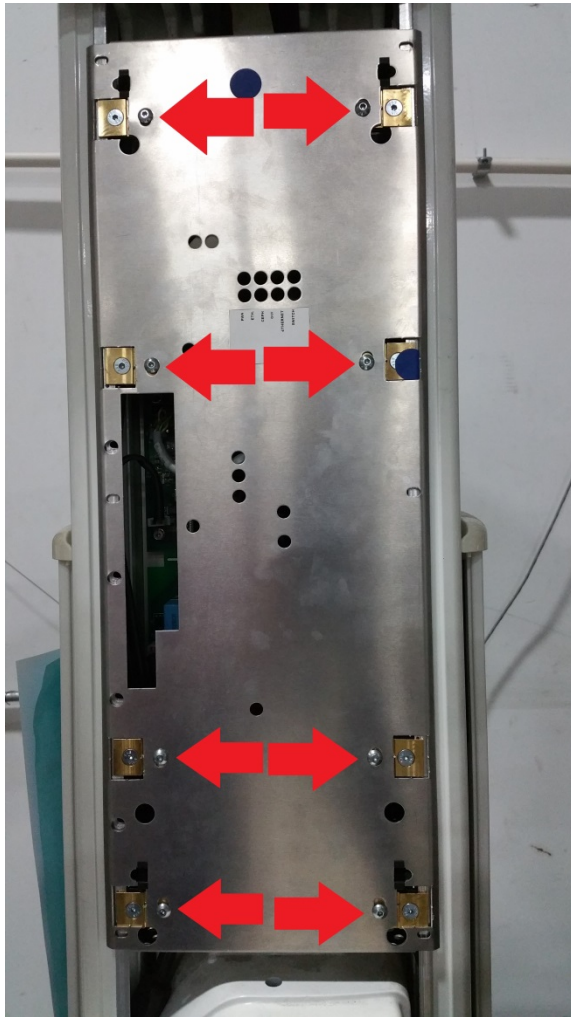

- The EMC shield for PSU2 can be detached by removing the eight 3mm Allen screws found next to the copper brackets along the sides.

Tube head cover plate

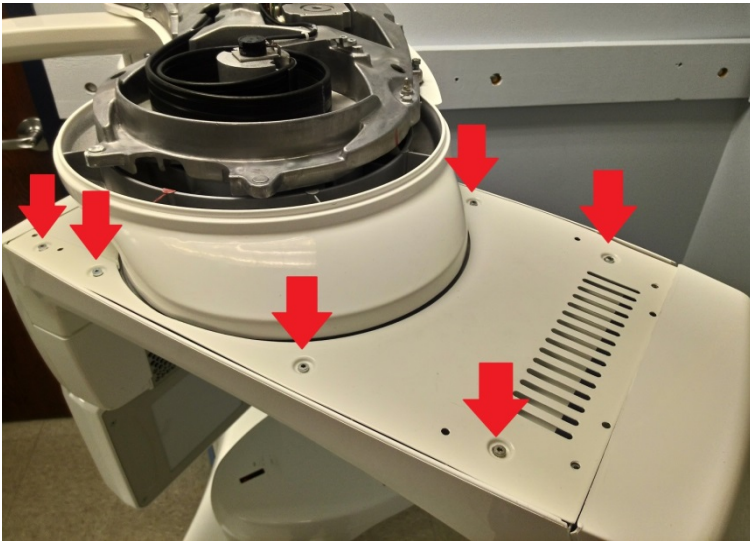

- The tube head cover plate can be detached by removing the eight 2.5mm Allen screws located along the edges of the cover on both sides and rotating the cover until it can be lifted at an angle and removed. ****This cover bends easily.**

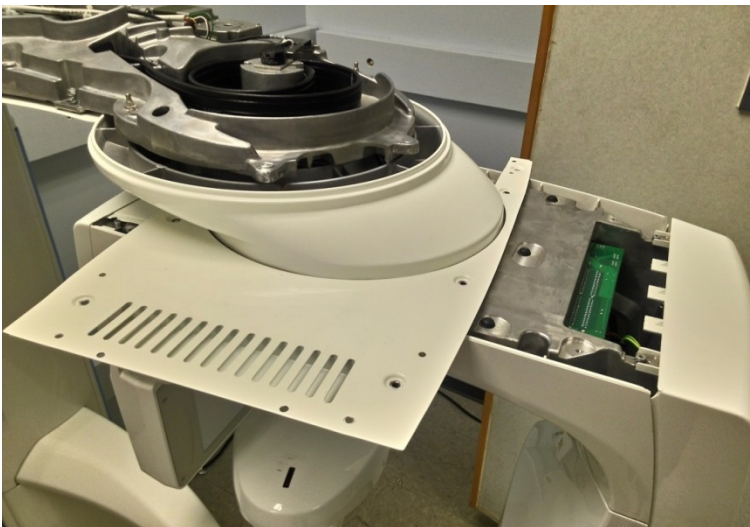

Tube head front cover

- The tube head front cover can be detached by loosening the two 3mm Allen rods found at an angle through the grill of the tube head cover plate. There are two ways to loosen these rods. The first is by removing the 8 screws from the **tube head cover plate** and turning the cover to open the top of the tube head. The second and faster method is to skip moving the cover and insert an Allen wrench through the holes found near the grill but **it is strongly recommended to use a 3mm ball end Allen to avoid stripping the screws.** These rods apply pressure to tabs found on the inside of the tube head front cover so they only need to be loosened a couple turns. Two 2.5mm Allen screws will also need to be loosened on the bottom of the tube head. See next slides for the methods and bottom screws.

Tube head front cover method 1

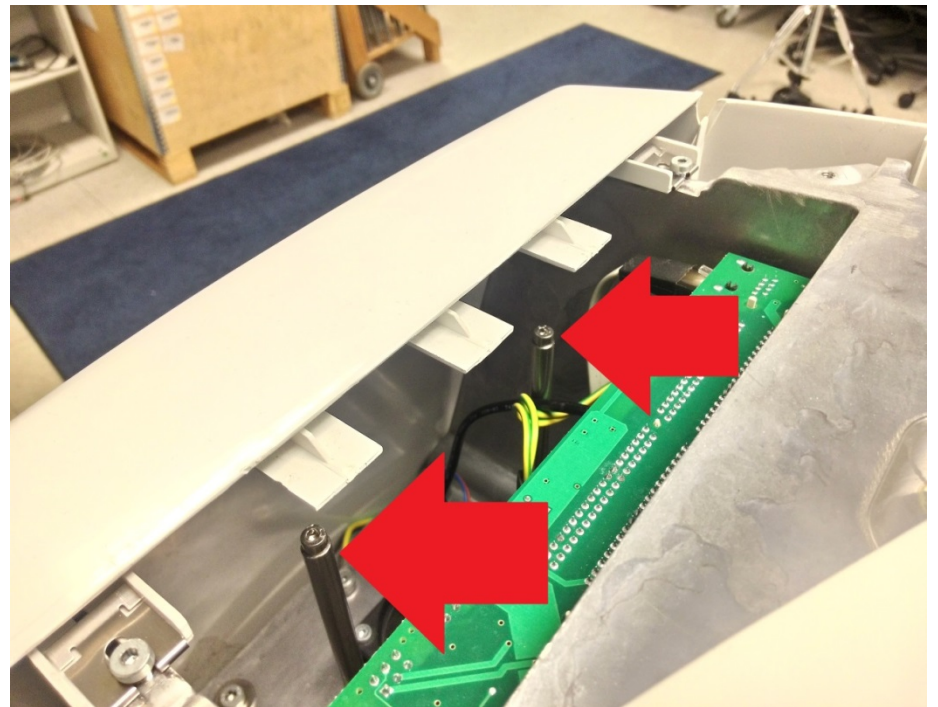
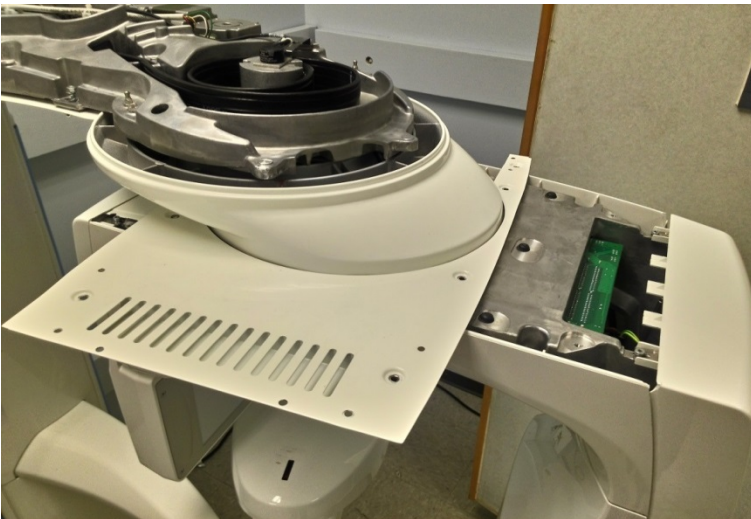
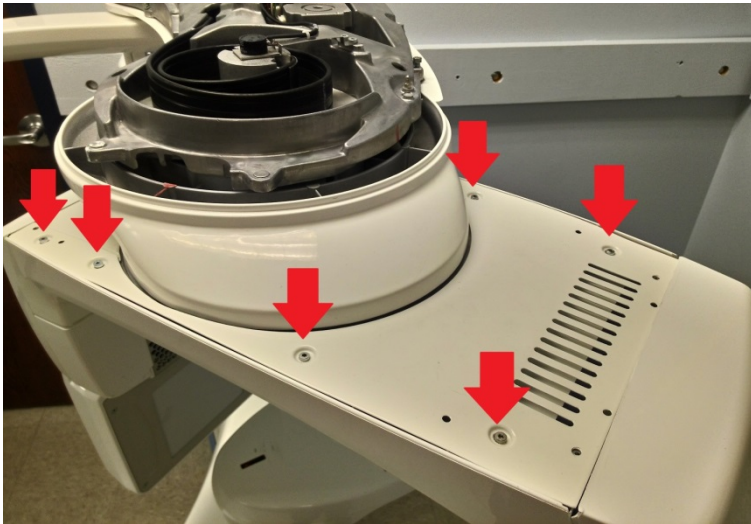

Tube head front cover method 2 and bottom screws

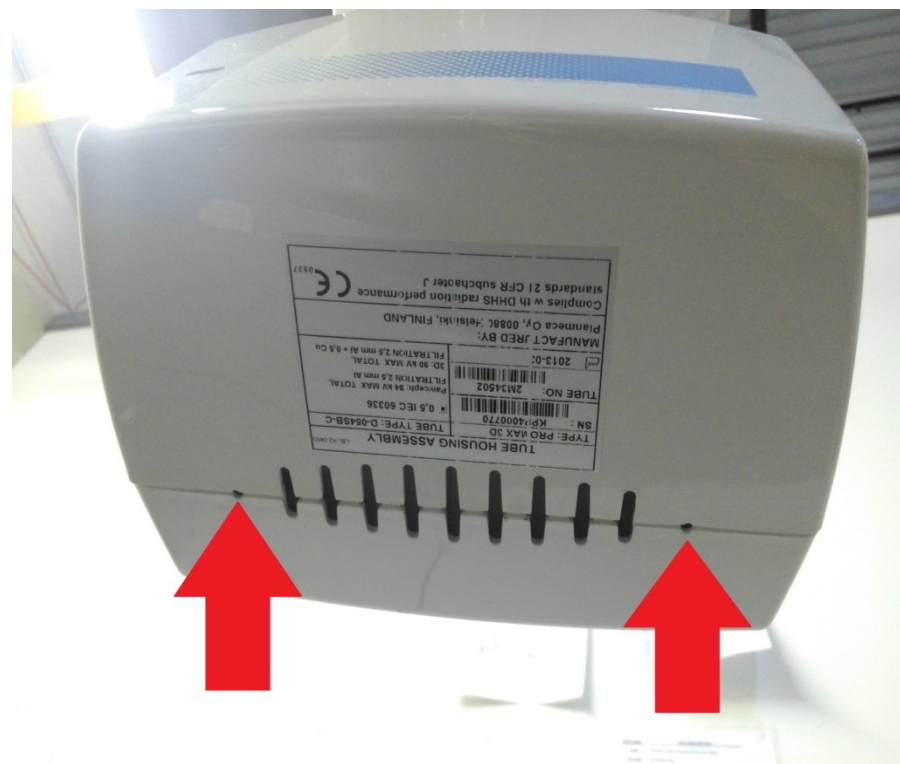

Tube head back cover

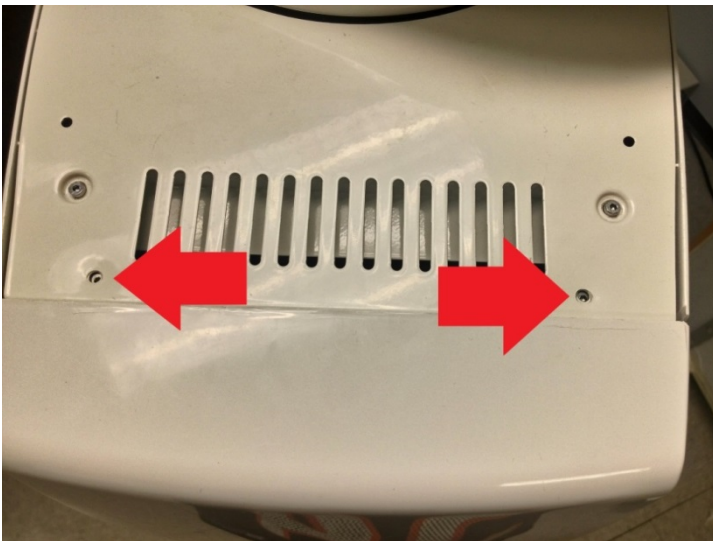
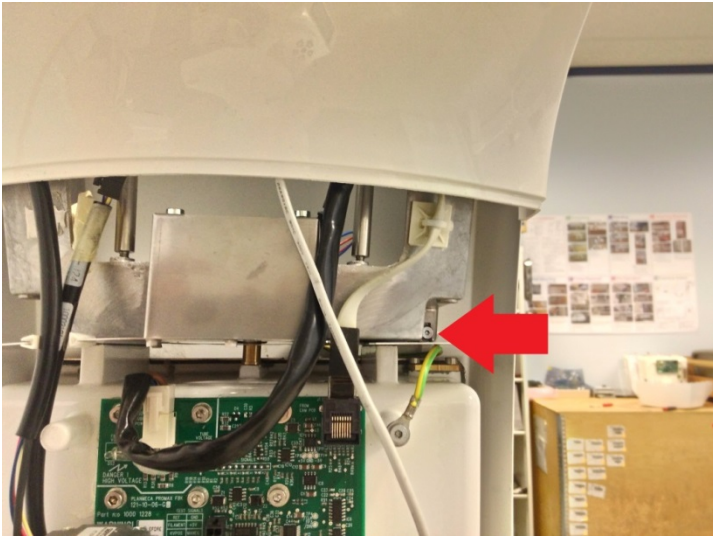

- With the tube head front cover detached, the tube head back cover can be detached by removing the two 2.5mm Allen screws found on both sides of the c-arm casting right above the tube head and loosening the two recessed 2.5mm Allen screws found on the tube head cover plate along the edge.

C-arm inner cover

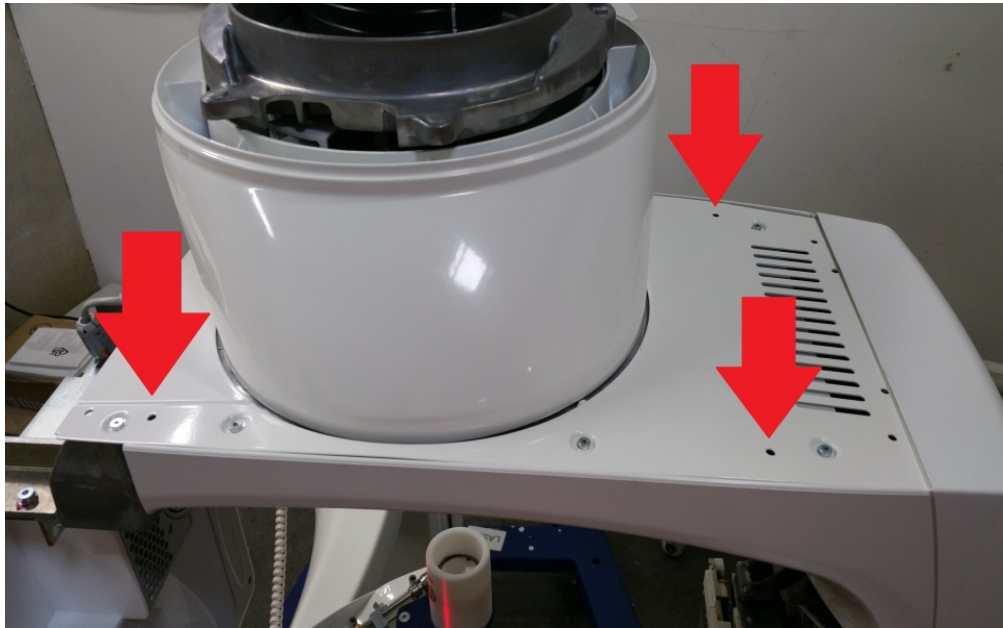

- The c-arm inner cover can be detached by fully loosening the four 2.5 mm Allen screws that are recessed in the holes closest to the elbow joint located along the edge of the tube head cover plate. The c-arm inner cover will drop once these four screws are loosened.

Quick connect pan sensor holder covers



- With the sensor removed, the front cover assembly can be detached by pulling on the sides of the cover towards the tube head.

Quick connect pan sensor holder covers

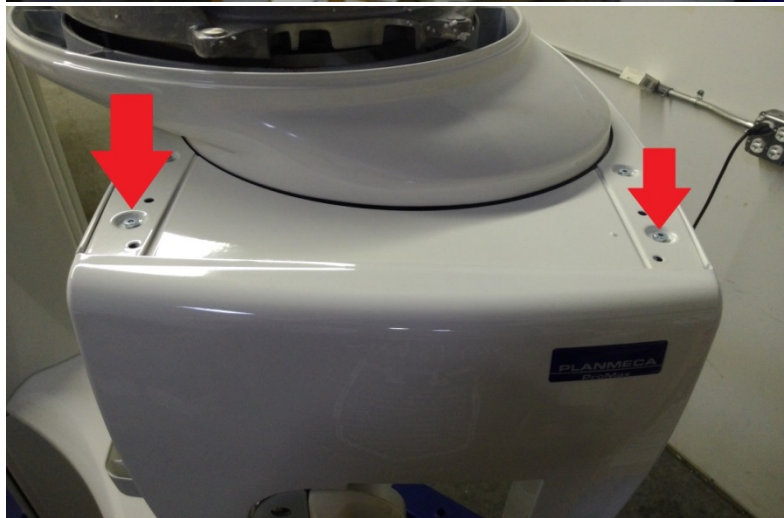
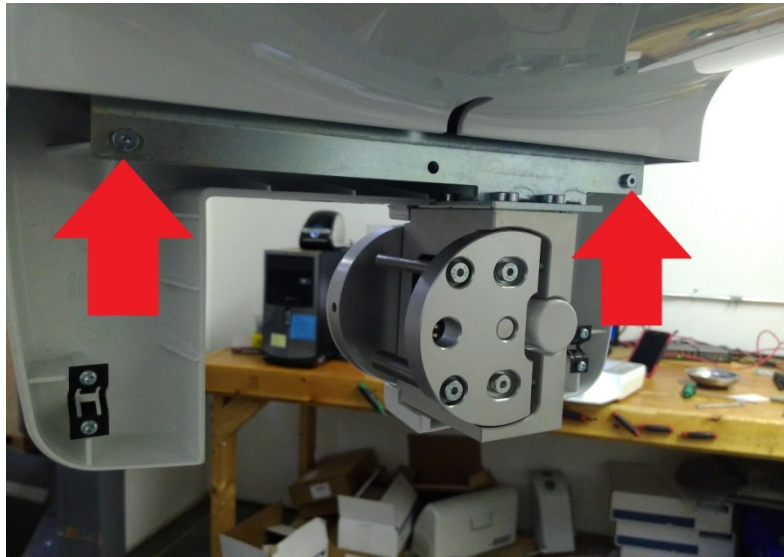

- The connector rear cover assembly can be detached by removing the two 2.5mm Allen screws found under the inner sensor cover and two 2.5mm Allen screws found on the top of the c-arm.

Fixed pan sensor holder covers



- The front cover assembly can be detached by pulling on the cover. It is held on by velcro.

Fixed pan sensor holder covers



- When the tube head cover plate is detached or rotated, it will reveal two 2.5mm Allen screws on the top of the connector rear cover assembly; remove these screws and the two 2.5mm Allen screws revealed inside on both sides of the sensor holder when the front connector assembly is detached.

Patient support cover

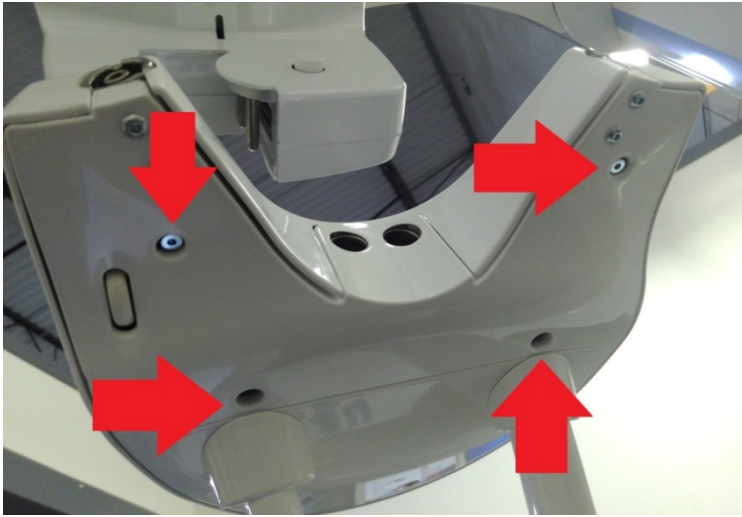

- The patient support cover can be detached by removing the five 2.5mm Allen screws found under the patient support body. The front screw has a shorter length than the back four.

Patient support arm lower cover



- The patient support arm lower cover is detached by unscrewing (8) 2.5mm Allen's found under the arm along the edges of the cover.

Column top cover with emergency switch

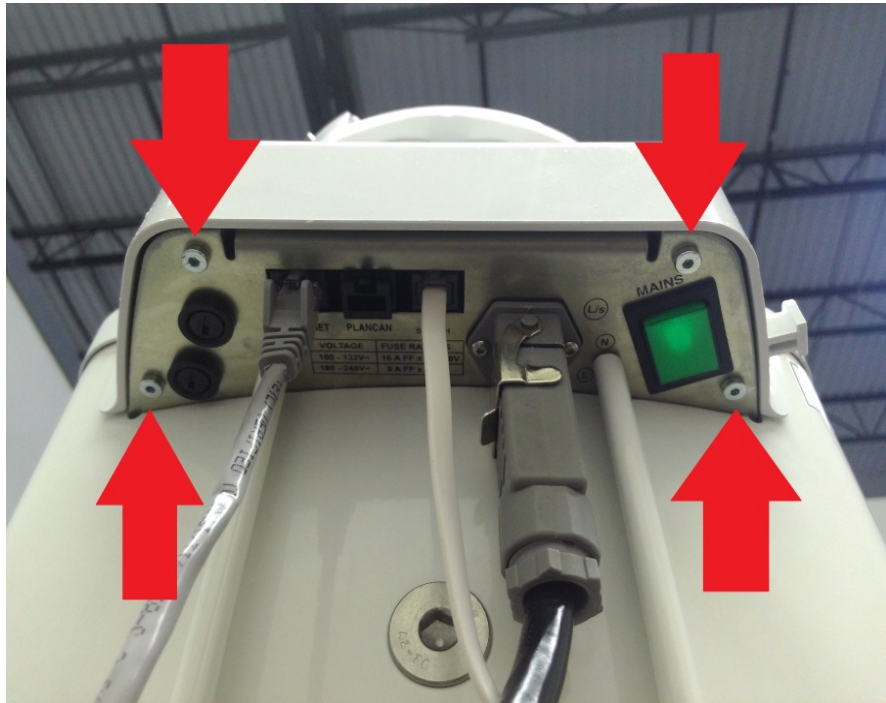

- The column top cover with emergency switch can be detached by removing the four 2.5mm Allen screws located on the bottom of the input module.

Column rear panel assembly



- The column rear panel assemblies can be detached by raising the unit as high as it will go and then pulling gently on the inner edge of each panel near the top. The panel will pop and then pull the panel horizontally inward to unclip the top and bottom pressure brackets of the panel from the side edge of the column. More images on next slide.

Column rear panel assembly

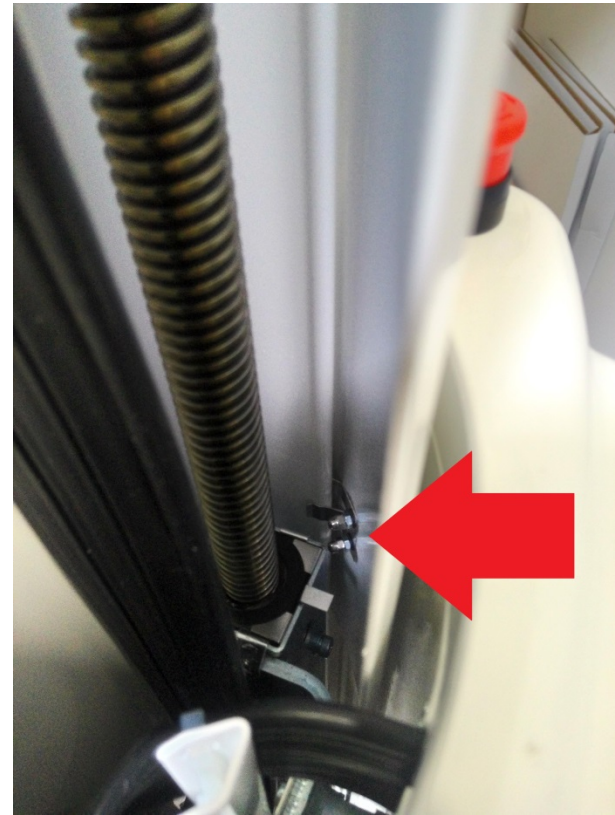
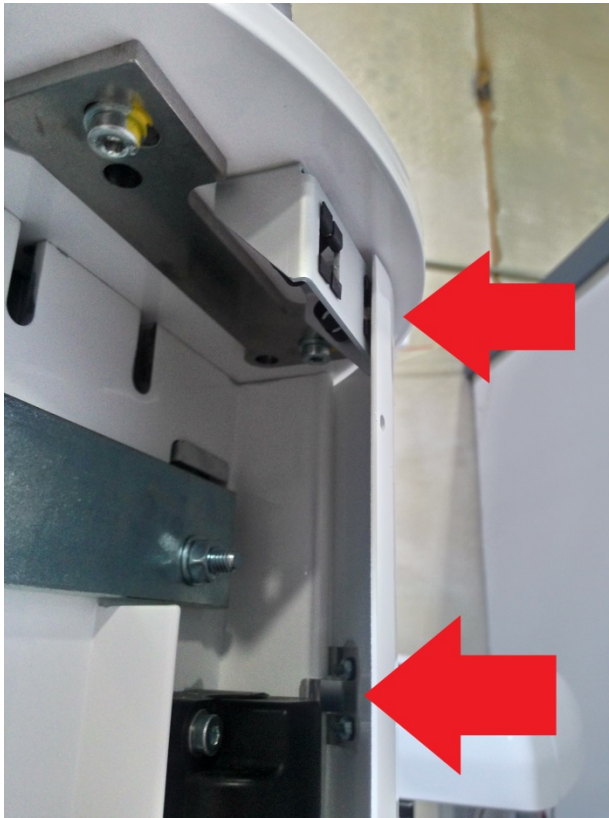

Collimator cover



- The collimator cover can be detached by removing the 2mm Allen screw on the bottom of the of the cover and pulling the cover out and down.

Collimator top cover box

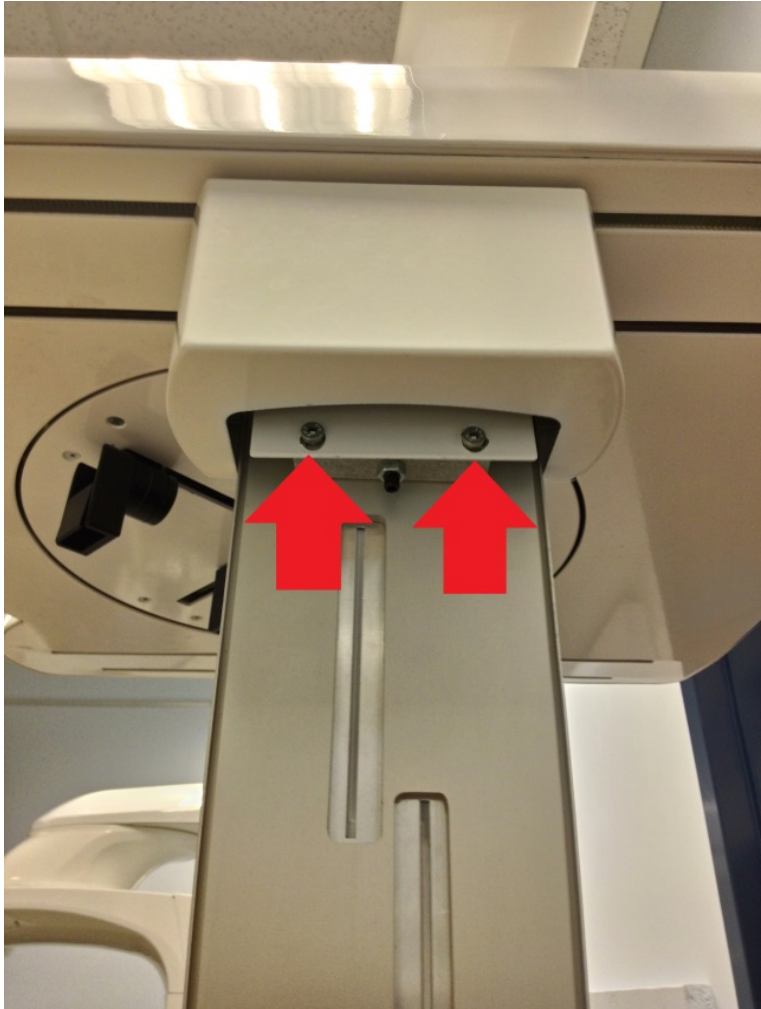

- The collimator top cover box can be detached by removing the two 3mm Allen screws revealed with the collimator cover detached.

Quick connect cephalostat sensor holder covers



- The sensor should be detached for the next 3 covers. The connector bottom plate can be detached by removing the Torx 30 screw found on the left edge of the cover.

Quick connect cephalostat sensor holder covers



- The connector back cover can be detached by removing the 4mm Allen screw revealed when the connector bottom plate is removed. Once the 4mm screw is removed, slide the cover towards the back of the machine to disengage the pressure clips found on the inside.

Quick connect cephalostat sensor holders covers

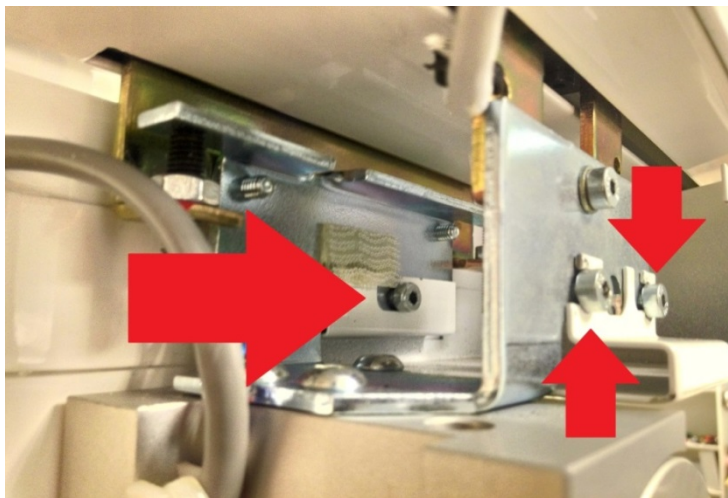
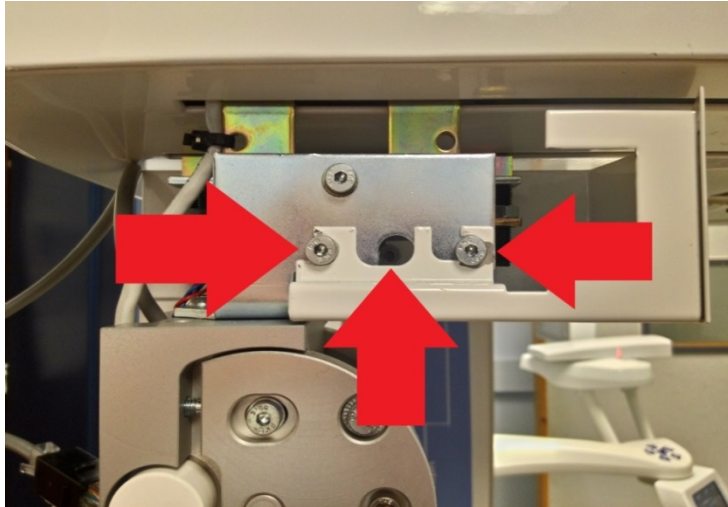

- The connector front cover can be detached by removing three 3mm Allen screws revealed once the connector back cover is detached. The screws are located on the outside of the sensor holder towards the top. **Note: Two of the screws will be holding the connector front cover by the outside while the last will be from the inside and can be accessed from the hole in between the two previously stated screws.

Fixed cephalostat sensor holder covers

- The connector bottom plate is the same on both sensor holders.

Fixed cephalostat sensor holder covers

- The connector back cover is the same on both sensor holders.

Fixed cephalostat sensor holder covers

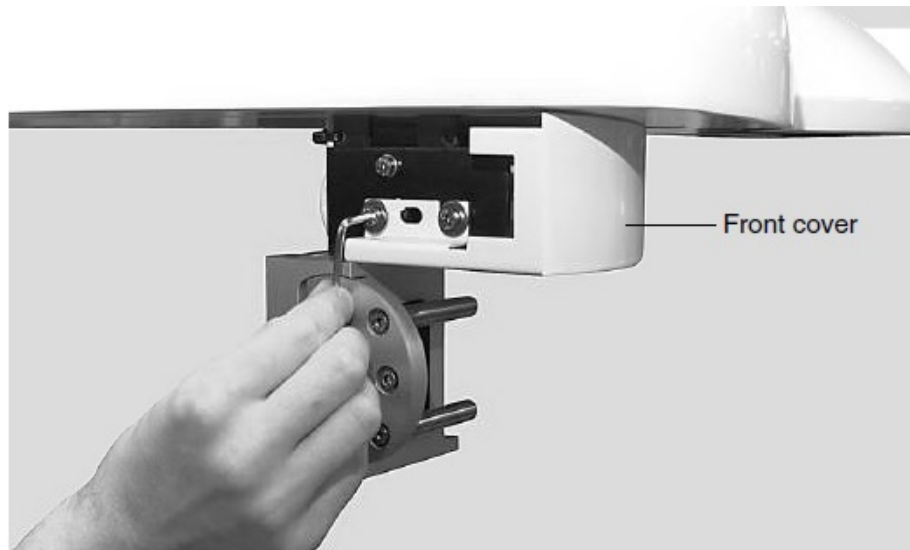

- The front cover for the cephalostat fixed sensor holder is the same as a quick connect holder except there are only two 3mm Allen screws revealed by removing the back cover.

Fixed cephalostat sensor holder covers



- The cephalostat fixed sensor holder locking plate can be detached by loosening the 3mm Allen screw located above the axle and pushing on the axle from the outside.

Front housing (old style)

- The **front housing** requires multiple steps to remove. Looking at the lower cover plate from under the unit, there will be six 3mm Allen screws that need to be loosened completely and one that should only be loosened 2-3 turns. All the screws are found inside the lower cover plate and can be accessed by rotating the ear posts and moving them in and out as needed. The 3mm Allen screw that should not be completely detached is found in the back right corner. Once all the screws are loosened, the back housing is held on by Velcro and can be lifted and then slid so the screw that was not fully loosened can move in its channel and the back cover be lifted. With the back housing detached, the last 3mm Allen screw to be loosened will be revealed inside and to the right of where the back housing was. The front housing can now slide back and be detached by lifting up. See next slide for more images.

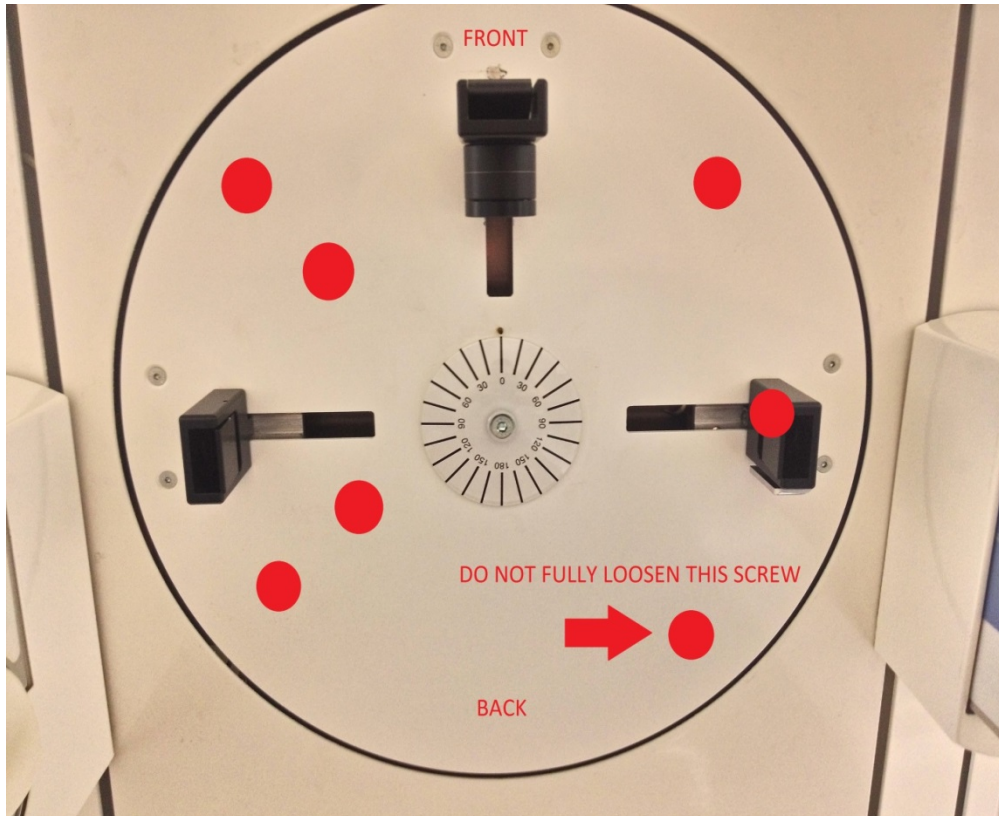

Front housing

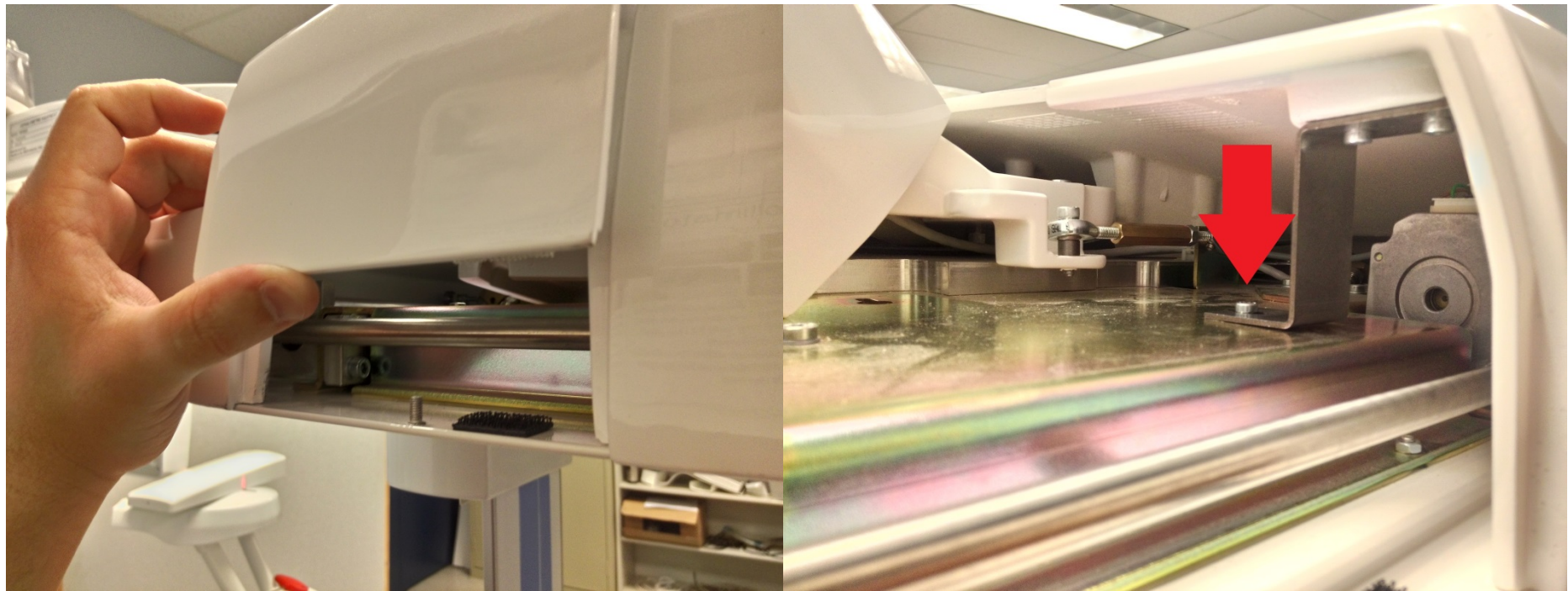

Front Housing (new style)

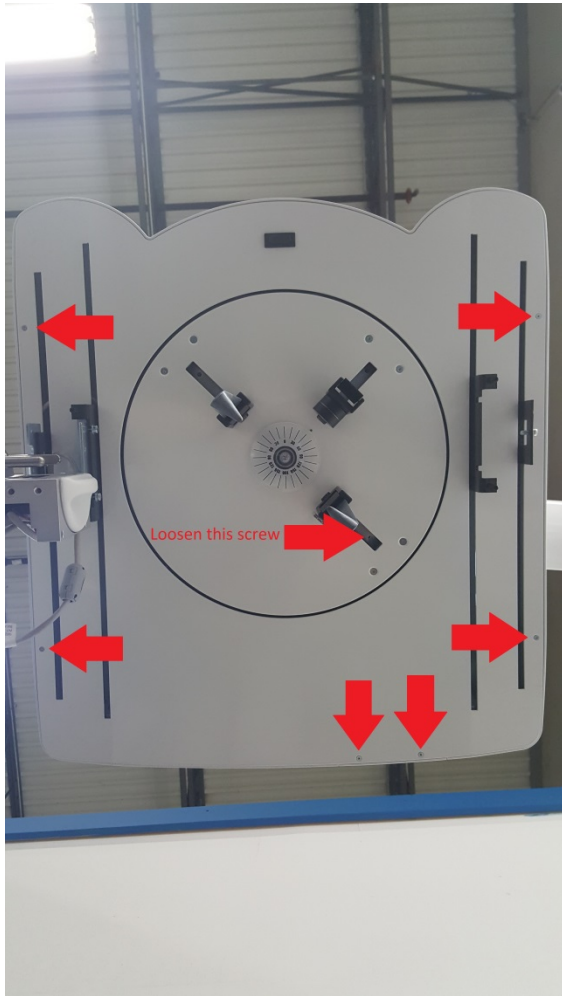

- Detach the new front housing by first removing the six Torx 8 screws found along the edges of the bottom cover. Then, loosen the Torx 8 screw found in the back right corner inside the lower cover plate at a 135 degree angle from the center dial. Once the inner screw is loosened and the six screws are removed, the back housing can be slide back and lifted up. The front housing can then be lifted straight up. This new front housing is held on by pressure clips and pins.

ProCeph front housing

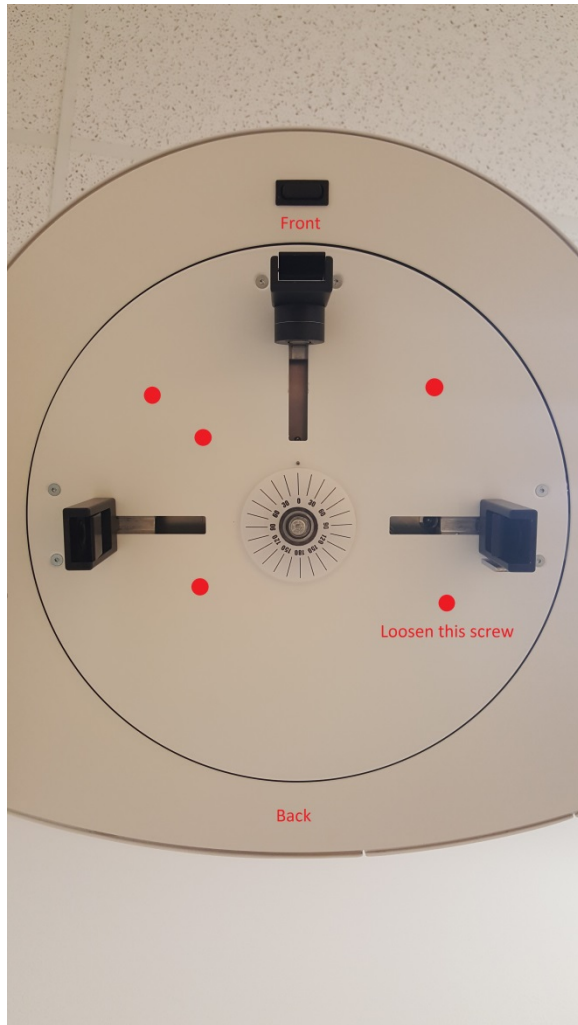

- Detach the ProCeph front and back housing by removing the five 3mm Allen screws located on the inside of the bottom cover plate. Three will be located on the sensor side with two at a 45 degree angle and one at a 120 degree angle. The last two are located on the opposite side with one at a 45 degree angle and one at a 120 degree angle. Once all five screws are removed, both the front and back housing covers may be lifted off the arm.

Rotating tube head

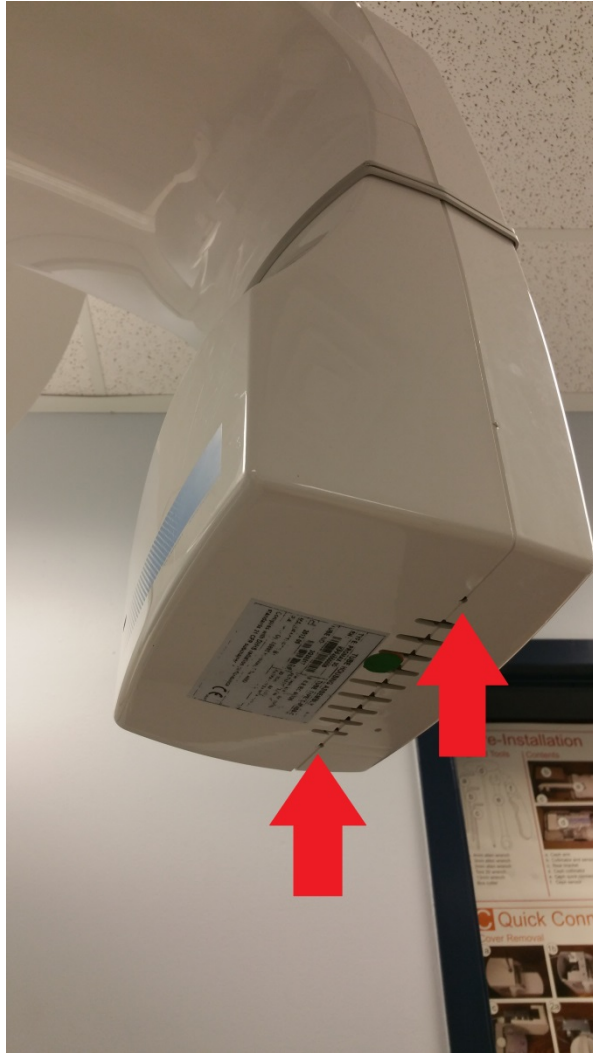

- Detach the lower front tube head cover by loosening the two 2.5mm Allen screws found on the bottom of the cover.

Rotating tube head

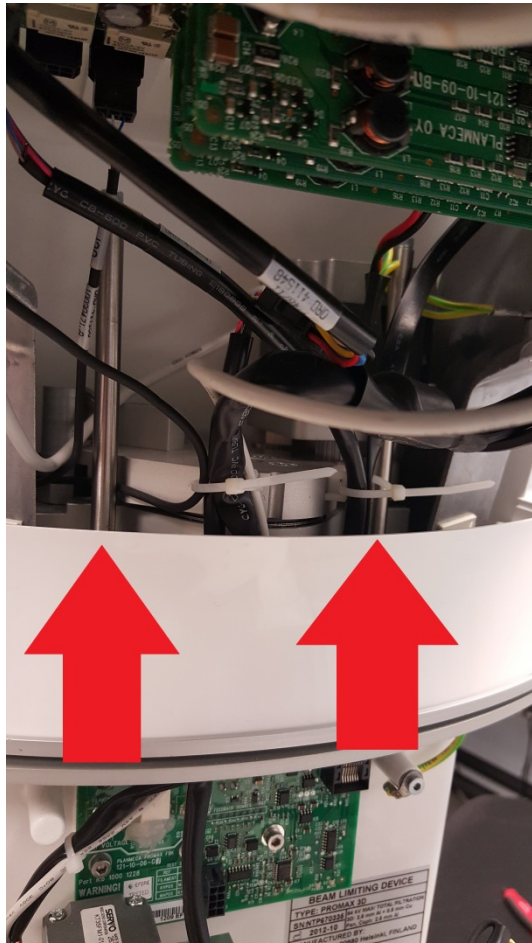

With the inner c-arm cover removed, detach the upper front tube head cover by loosening the 3mm Allen screw topped metal rods that apply pressure to the clips on the inside of the cover. These rods can be accessed by holes located directly above them.

Rotating tube head

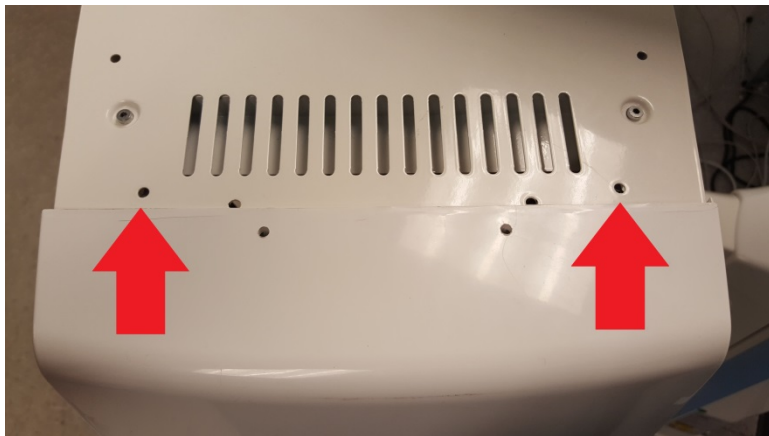
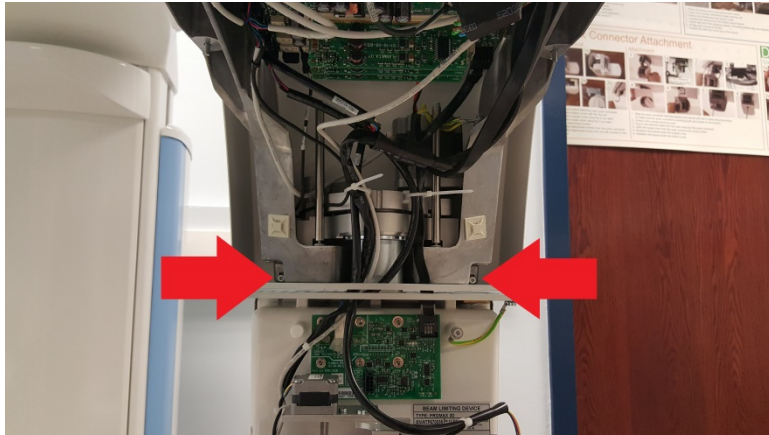

- With the upper front tube head cover removed, detach the upper rear tube head cover by removing the two 2.5mm Allen screws found on either side of the casting above the rotation plates and loosening the two 2.5mm Allen screws found on the rear near the edge of the cover plate where the two covers meet.

Rotating tube head

- Detach the lower rear tube head cover by removing the two 2mm Allen screws located on either side of the rotation plates.

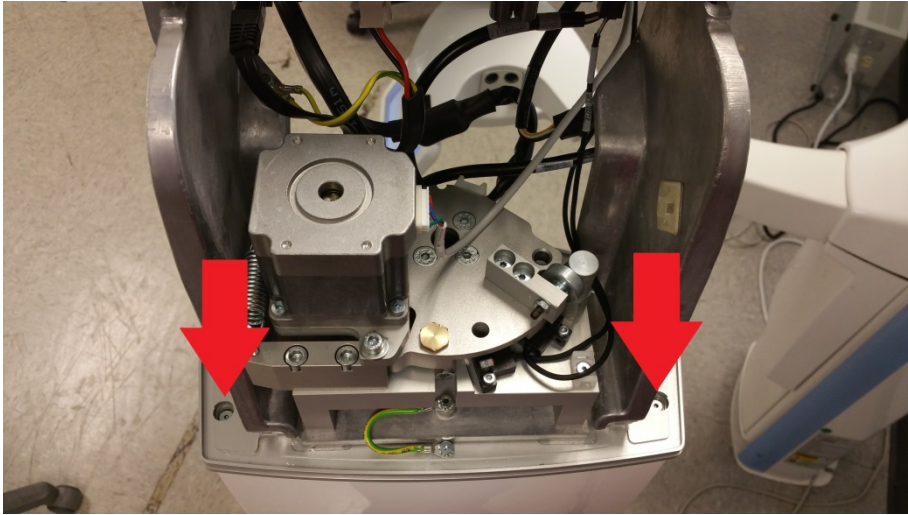

ProMax Max/Mid/Plus covers

Plus/MID/MAX Lower front cover



- Refer to promax lower front cover panel.

Upper front cover



- The patient support moving mechanism is in the way of removing the upper front cover on a ProMax Max/Mid/Plus. The unit should put into positioning mode by starting a full skull 3D x-ray capture sequence and the turn arrow keys on the patient position control PCB will allow the patient support moving mechanism to be moved up or down as needed.

Carriage cover

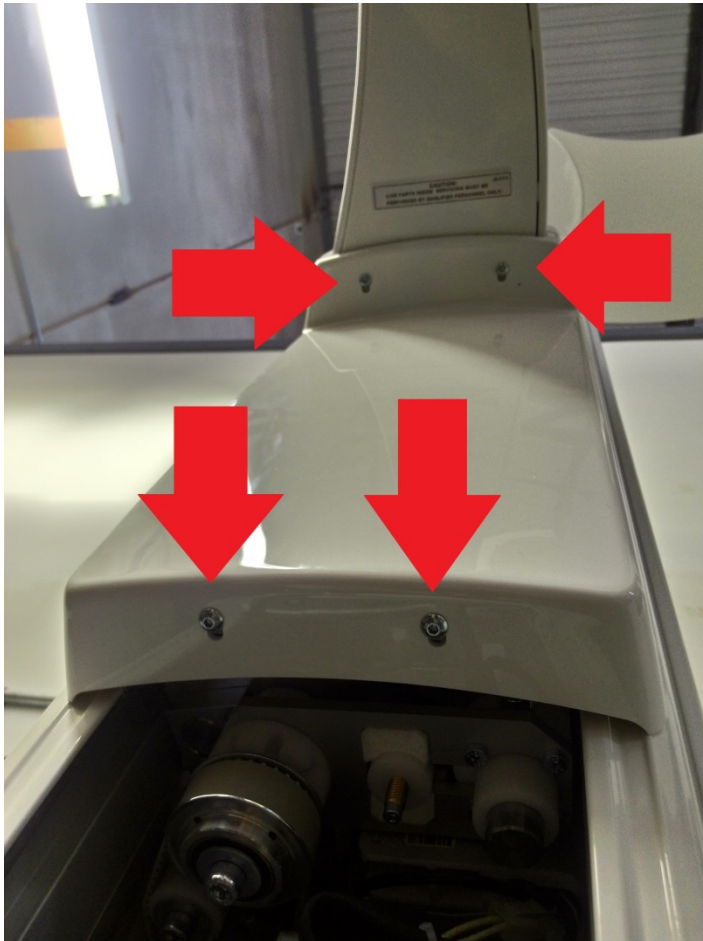

- The carriage cover can be detached by removing the four 3mm Allen screws located the bottom of the cover. Two will be right below the patient support arm and two on the very bottom of the cover.

Plus/MID sensor head front cover

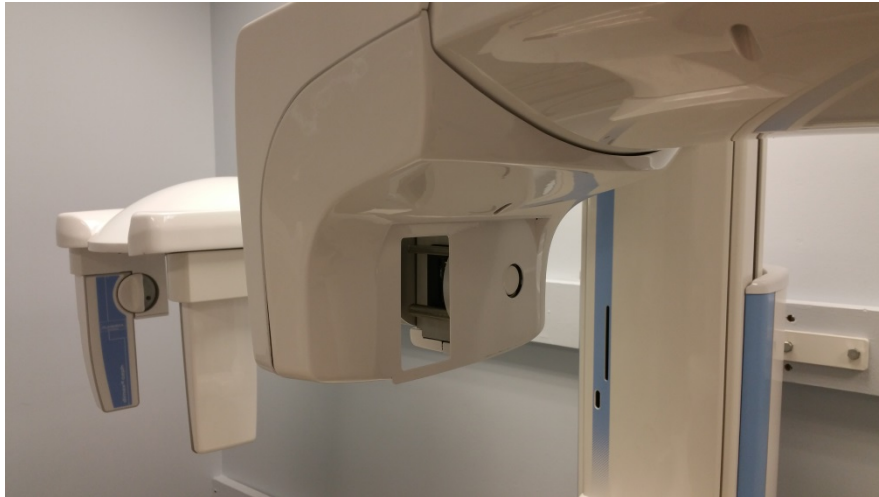

- The plus/mid sensor head front cover can be detached by pulling on the sides of the cover towards the tube head.

Plus/MID sensor head back cover



- The Plus/MID sensor head back cover can be detached by loosening the two 2.5mm Allen screws located on top, recessed in holes along the edge of the cover and removing the two 2.5mm Allen screws revealed when the sensor head front cover is removed on either side of the sensor holder.

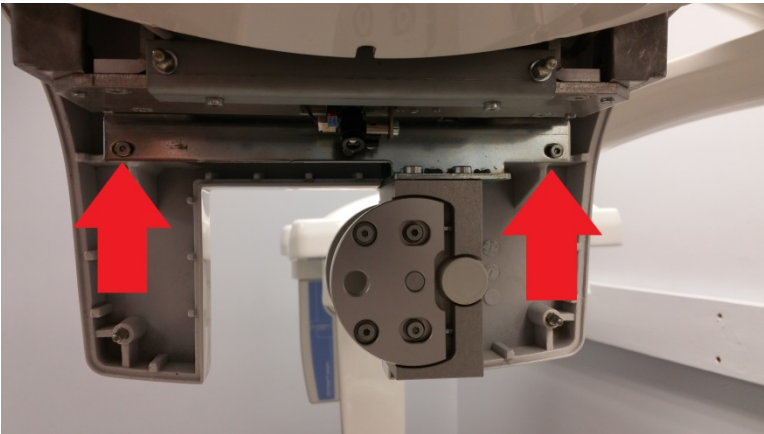

Max sensor head front cover

- The ProMax Max sensor head front cover can be detached by removing the two 2.5mm Allen screws located on the bottom of the cover and the 2.5mm Allen screw located in the middle of the top portion of the cover.

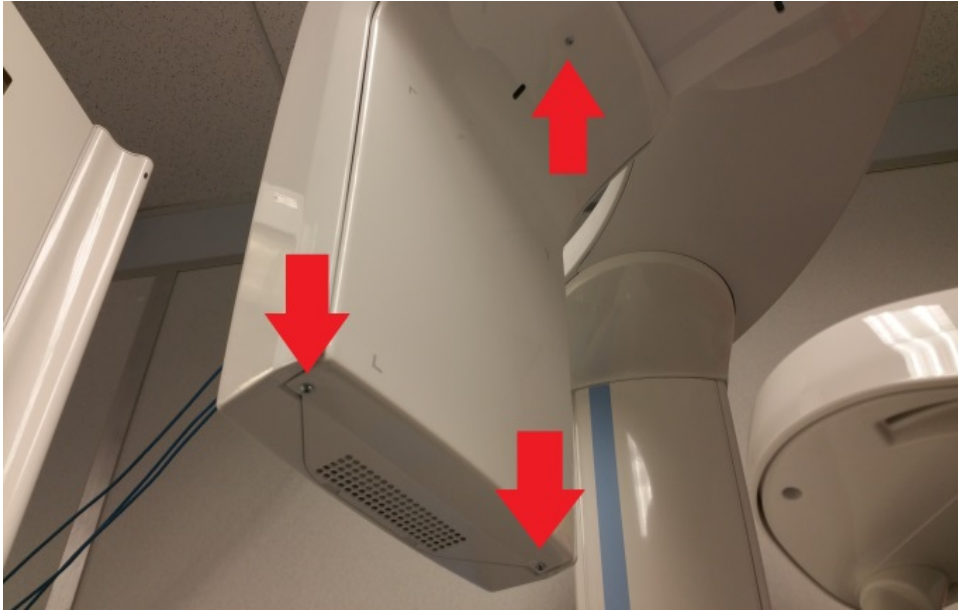

Max sensor head back cover

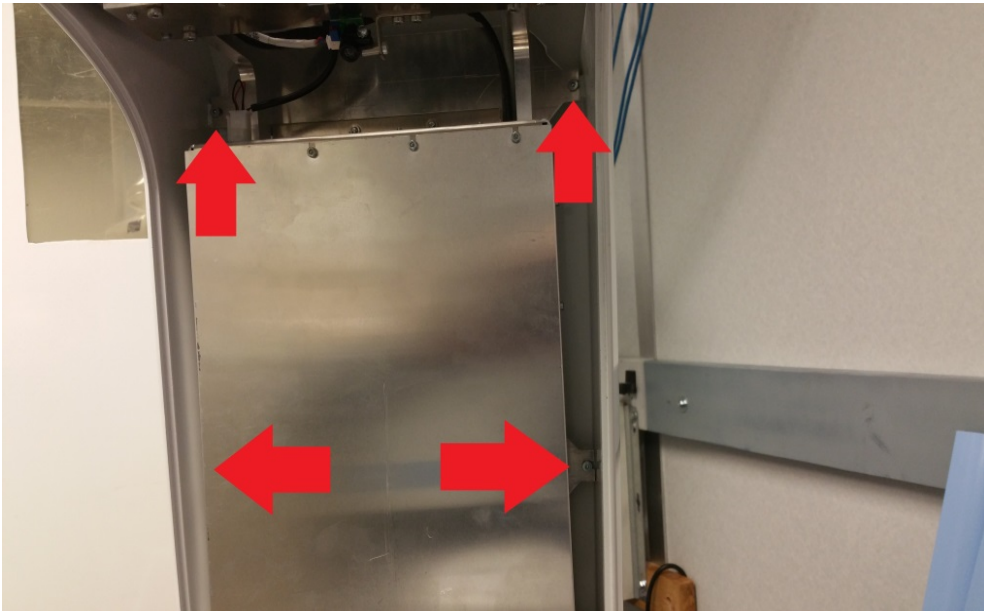

- The ProMax Max sensor head back cover can be detached by removing the four 2.5mm Allen screws located on the inside of the cover revealed once the sensor head front cover is detached. Two of the screws are located towards the top while the other two are located close to the middle of the cover on the left and right sides of the sensor.

ProOne

Door assembly



- The door assembly can be opened by unscrewing the adjustment stick and pulling from the base of the door. Since the door is held closed by pressure clips and pins, it should pop out when pulled.

Upper arm assembly

- The upper arm assembly can be detached by simply lifting the cover up.

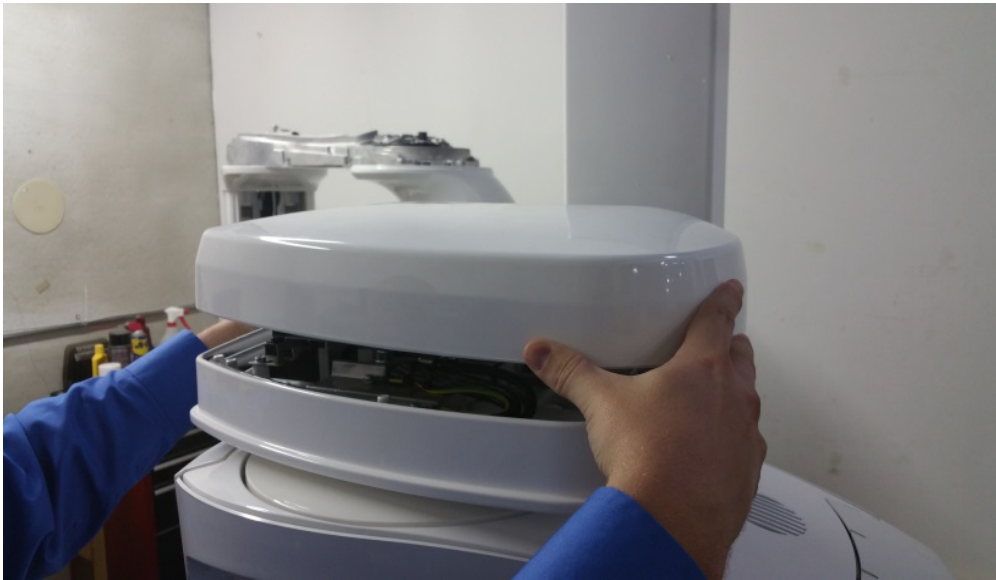

Tube head front cover

- The tube head front cover can be detached by loosening the 2.5mm Allen screw located on the bottom of the cover. Once this screw is loosened, gently pull from the base while leaving the top portion still on the tube head and then down once at a 45 degree angle. The angle is to avoid breaking the two plastic arms that slide up under the c-arm cover.

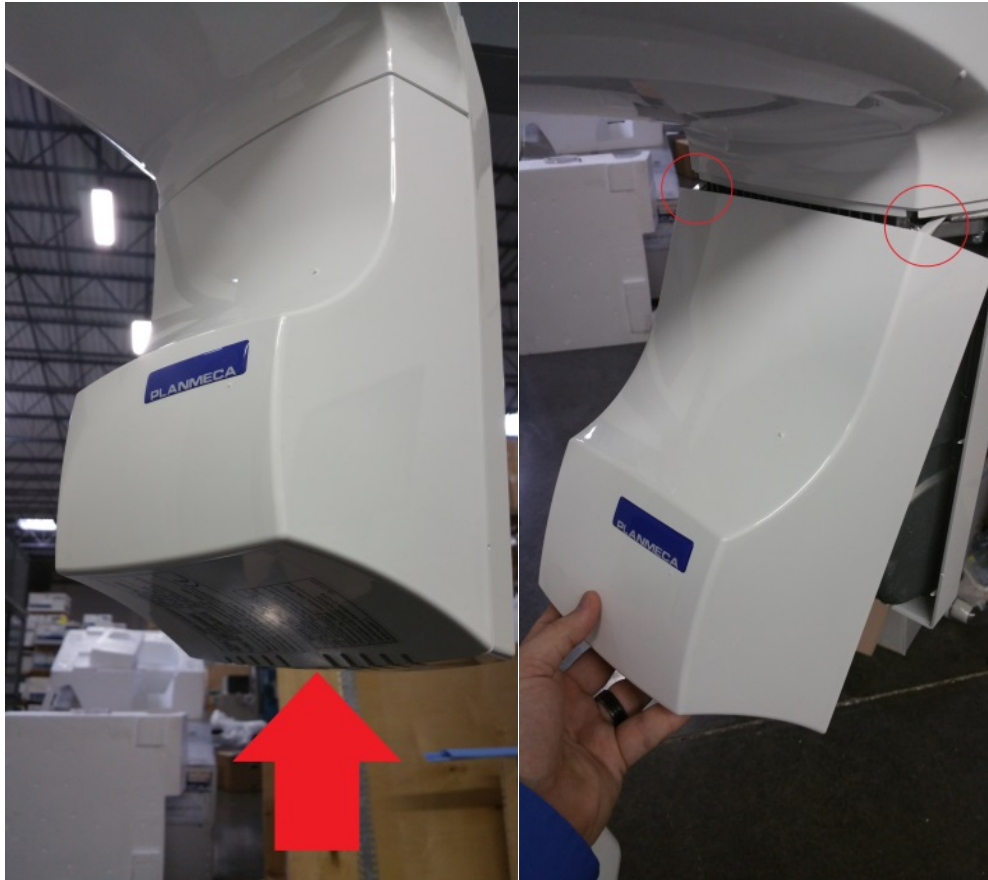

Tube head rear cover



- Once the tube head front cover is detached, the tube head rear cover can be detached by loosening the two 2.5 mm Allen screws located at the top of the cover.

Sensor cover



- The sensor cover can be detached by loosening the 2.5mm Allen screw found at the top of the cover where it meets the c-arm cover and the 2.5mm Allen screw located on the bottom.

C-arm cover

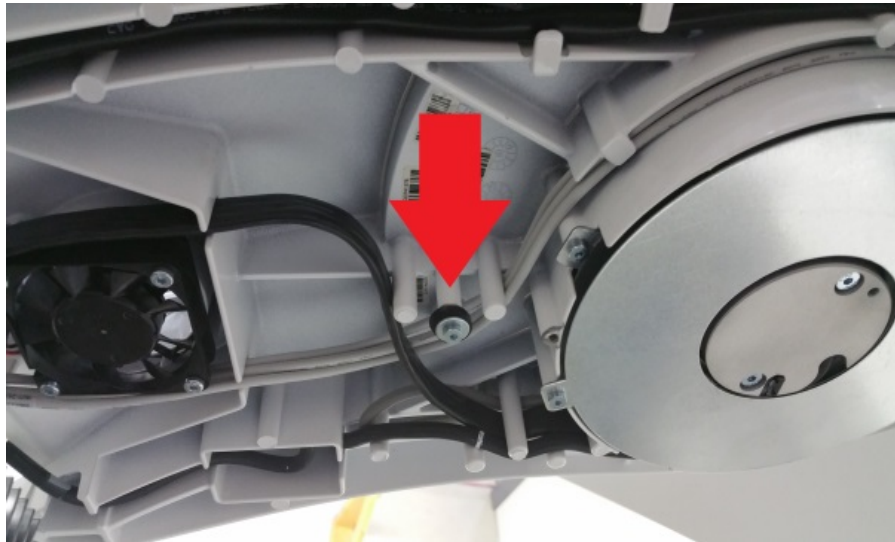

- Once the tube head front cover and sensor cover are detached, the c-arm cover can be detached by gently pulling down on the cover from the sides. The c-arm cover is held on by a rubber damper located towards the center of the cover.

Patient support cover

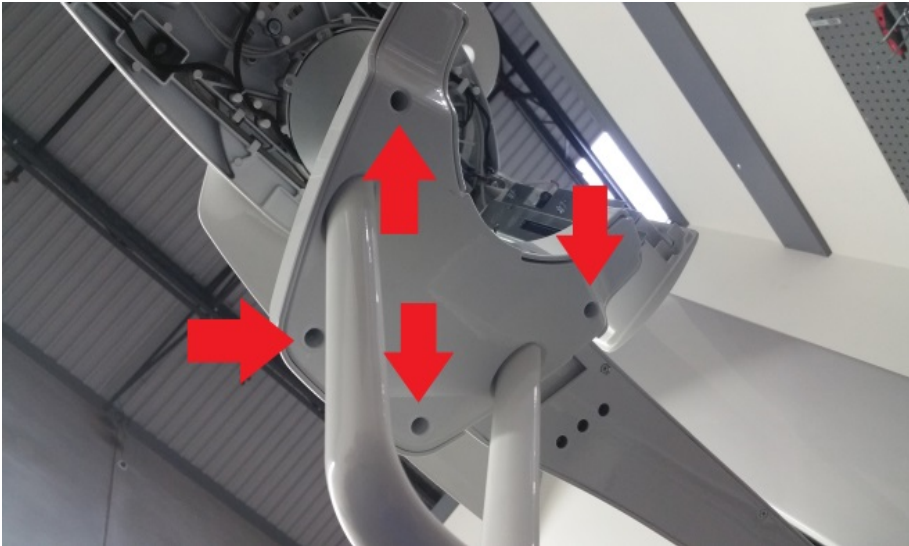

- The patient support cover can be detached by removing the four 2.5mm Allen screws located underneath the patient support frame.

Column bottom and column top

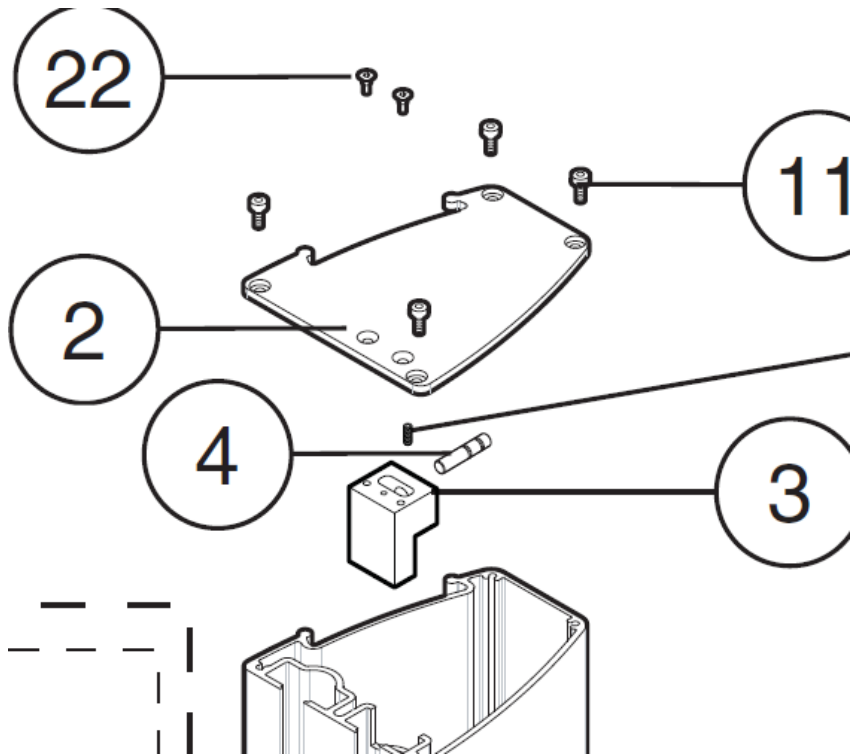

- Both the column bottom and column top can be detached by removing the four Torx 25 screws located at the corners. (Number 11 in the picture)

ProX

Upper cover assembly

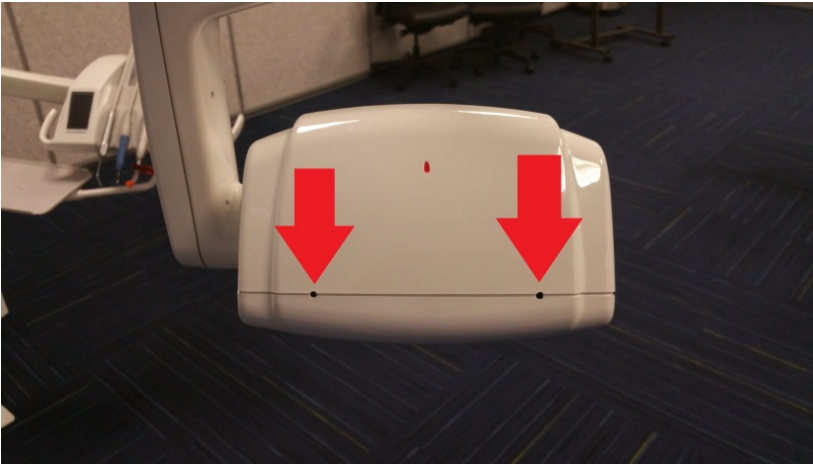
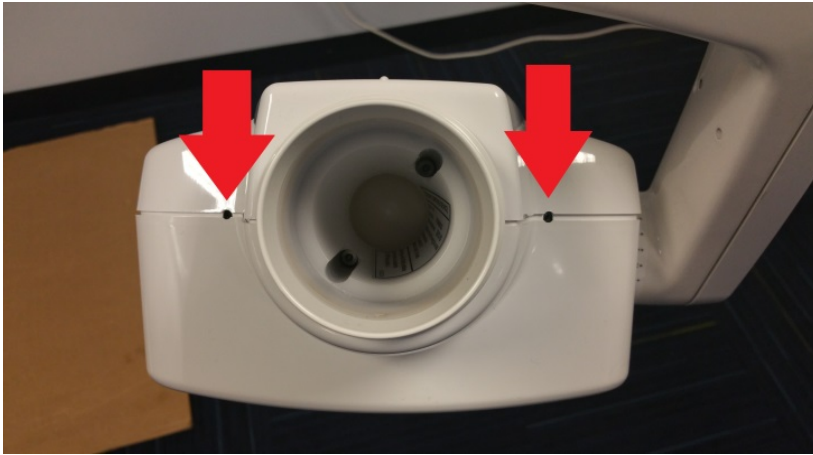

- The upper cover assembly can be detached by loosening the two 2.5mm Allen screws found on the front and the two 2.5mm Allen screws on the back of the tube head where the upper and lower covers meet.

Lower cover assembly

- Once the upper cover assembly is off, the lower cover assembly can be detached by removing the two 2.5mm Allen screws found on either side of the tube head and the two 2.5mm Allen screws found deep inside the cover near the front of the tube head.

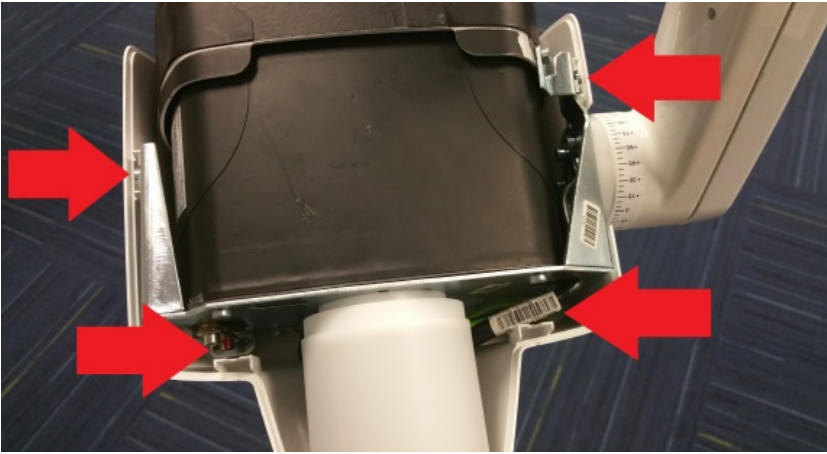

Tube head support cover assembly

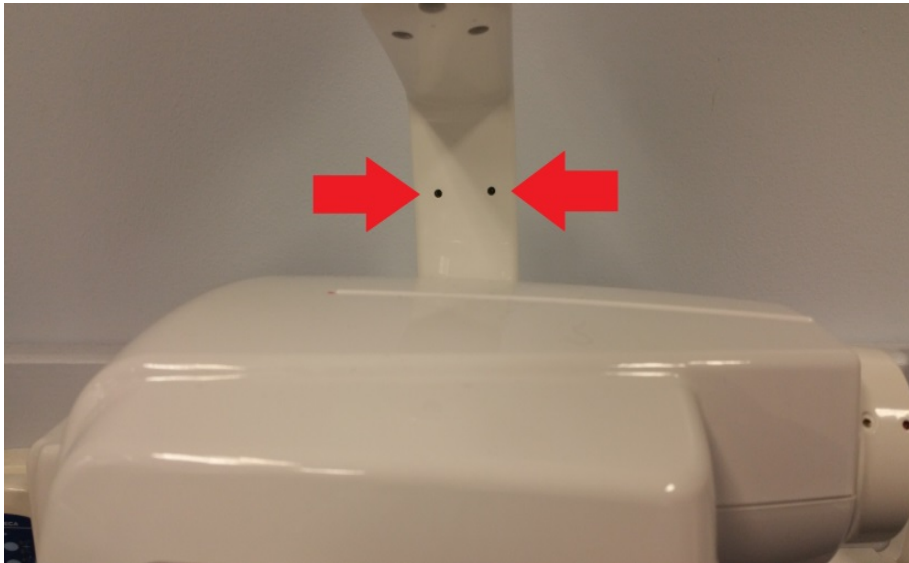

- The tube head support cover assembly can be detached by loosening the two 3mm Allen screws located on the inside of the tube head support slightly above where the support frame meets the tube head support.

Balanced arm cover

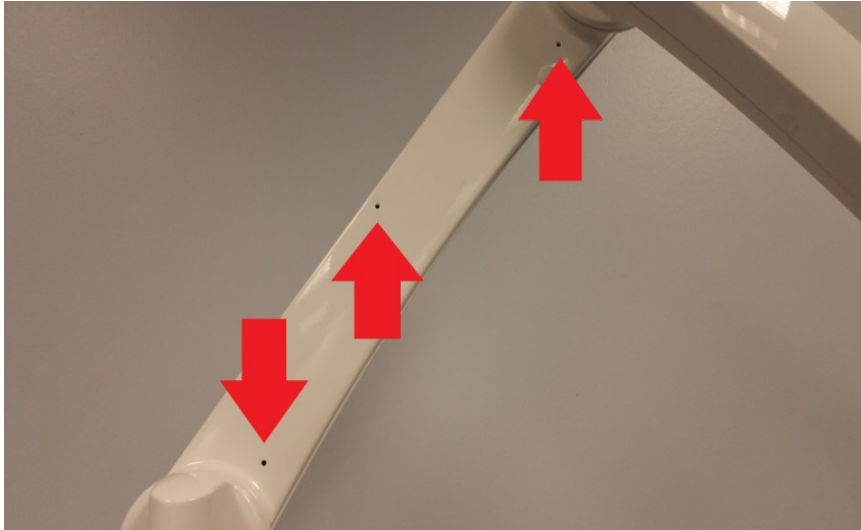

- The balanced arm cover can be detached by loosening the three 3mm Allen screws found in the holes on the back side of the arm. These screws are recessed in channels and will not fall out when completely unscrewed.

Generator cover

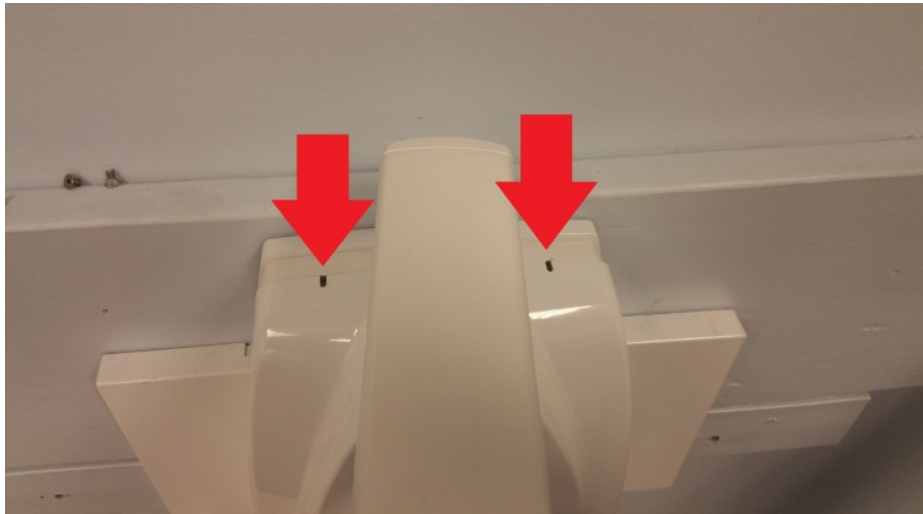

- The generator cover can be detached by loosening the two 2.5mm Allen screws located on the top of the cover on either side of the horizontal arm and the two 2.5mm Allen screws found on the bottom of the cover on the left and right side of the generator PCB frame plate.

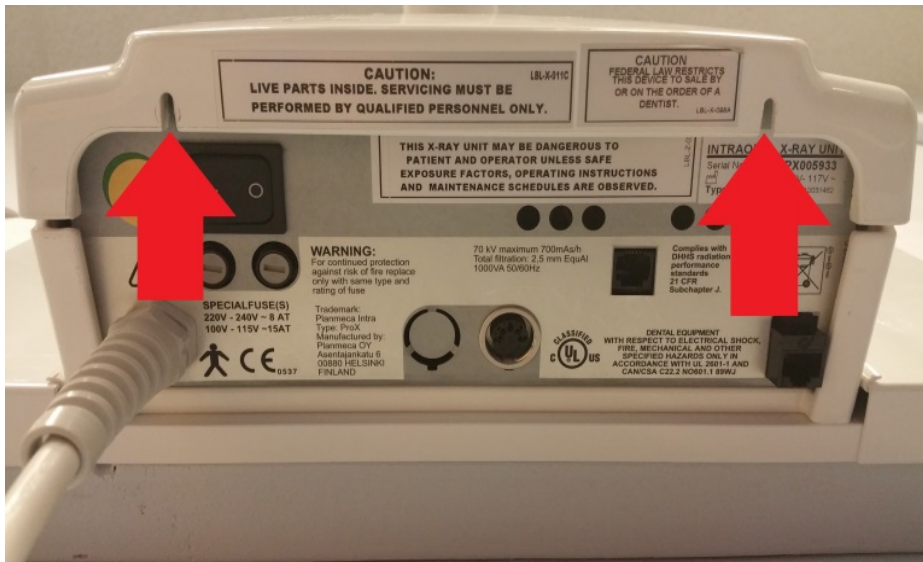

Fixed control unit housing



- The fixed control unit housing can be detached by loosening the 2.5mm Allen screw found on the bottom of the cover.

Control unit front cover and back cover

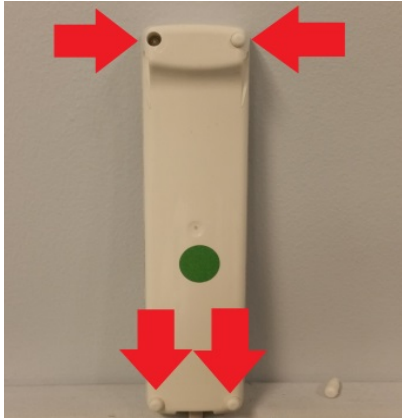

- The control unit front cover and control unit back cover can be separated by pulling the rubber feet from the control unit back cover to reveal four Torx 10 screws that need to be removed.



Single stud cover

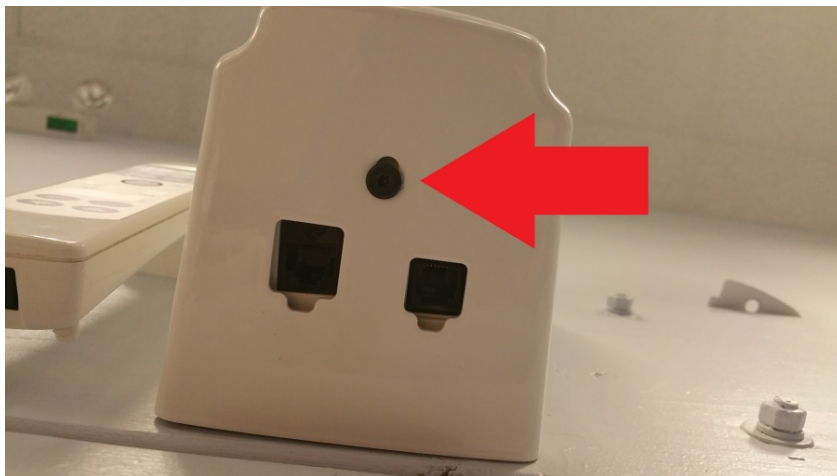

- The single stud cover can be detached by removing the two 3mm Allen screws located on the top of the cover and the 3mm Allen screw located on the bottom of the cover.

Planmeca Intra

Tube head front cover



- The tube head front cover can be detached by removing the two 2.5mm Allen screws located inside the cone of the tube head.

Tube head back cover

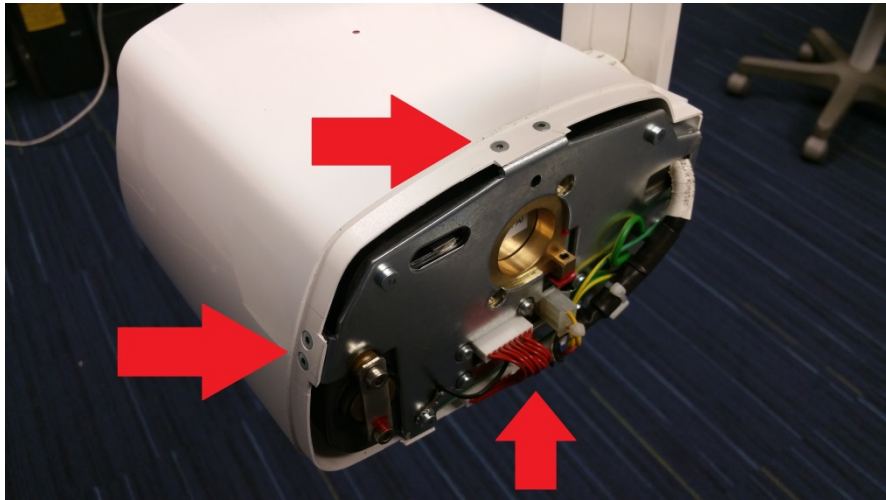

- With the tube head front cover off, the tube head back cover can be detached by removing the six 2mm Allen screws found along the front edge of the cover.

Generator housing

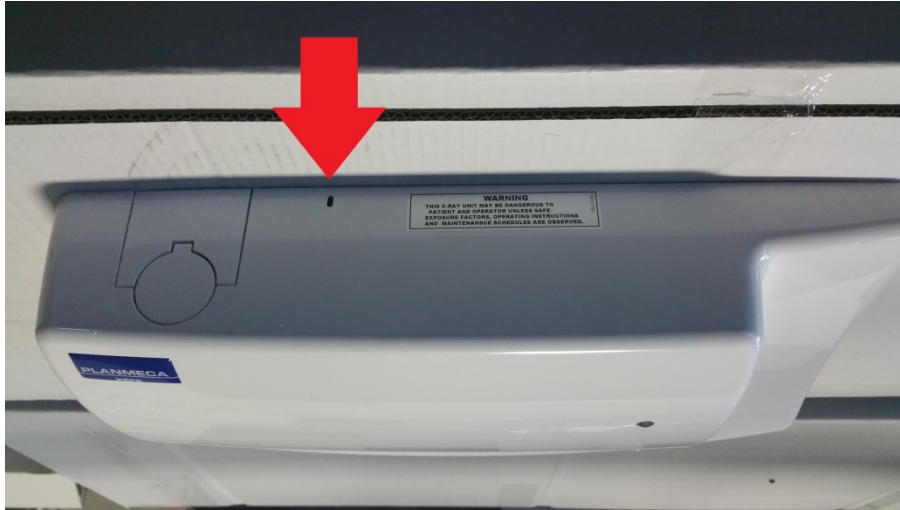

- The **generator housing** can be detached by loosening the 2.5mm Allen screw on top of the cover next to the horizontal arm and the two 2.5mm Allen screws located on the bottom of the cover at each end of the generator board.

Fixed control panel unit housing

- Refer to ProX fixed control unit housing.

Control unit front cover and back cover

- Refer to ProX control unit front and back cover.

Single stud cover



- The single stud cover can be detached by removing the 2.5mm Allen screw located in the middle of the cover.

ProStyle Intra

Tube head front cover

- Refer to Planmeca Intra tube head front cover.

Tube head front back cover

- Refer to Planmeca Intra tube head back cover.

Generator housing

- Refer to Planmeca Intra generator housing.
Note The Prostyle Intra generator housing cover is metal while the Planmeca Intra generator housing is plastic.

Fixed control panel cover

- The fixed control panel housing can be detached by removing the two 2.5mm Allen screws located on the bottom of the cover.



Control panel assembly

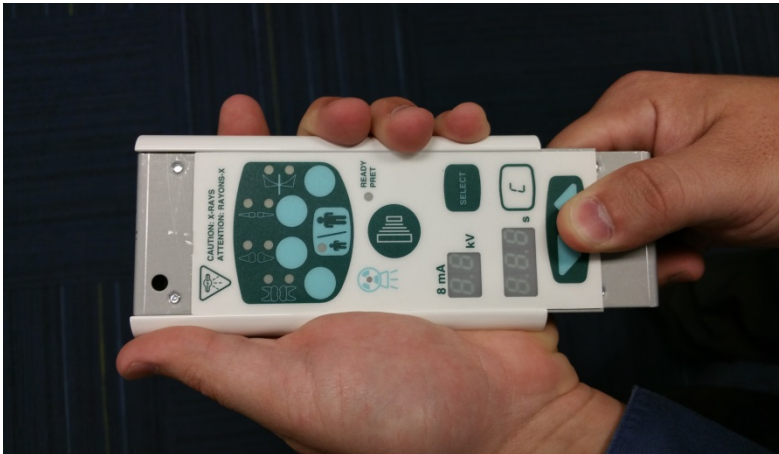

- The control panel assembly can be dismantled by first removing the attachment plate on the back by removing the two 2mm Allen screws and then pulling off the upper and lower rubber covers. Next, the control panel frame can be detached by holding the cover plate while pulling up on the control panel frame.

Single stud cover

- Refer to PlanMeca Intra single stud cover.

Proline Pans

Upper cover

- Before removing the upper cover, the dust cover must be detached. Press the mm – on the touchpad or the layer left button on the GUI until the patient positioning mechanism will move no more. Push the U shaped dust cover back to reveal the lip at the front and lift it out. Then move the patient position mechanism back over the hole in the upper cover. Continued on next page.

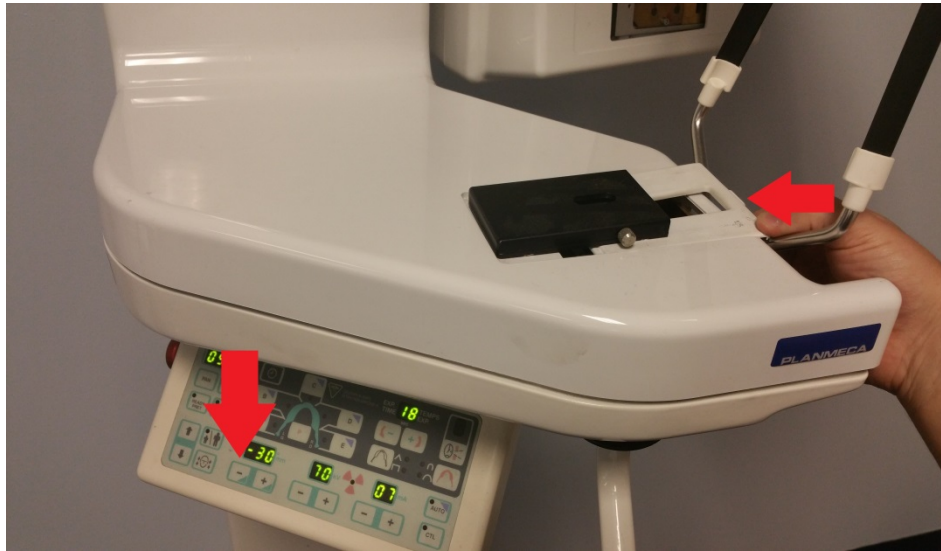

Upper cover

- The upper cover can be detached by removing the four 3mm screws located under the table behind the GUI or touchpad.

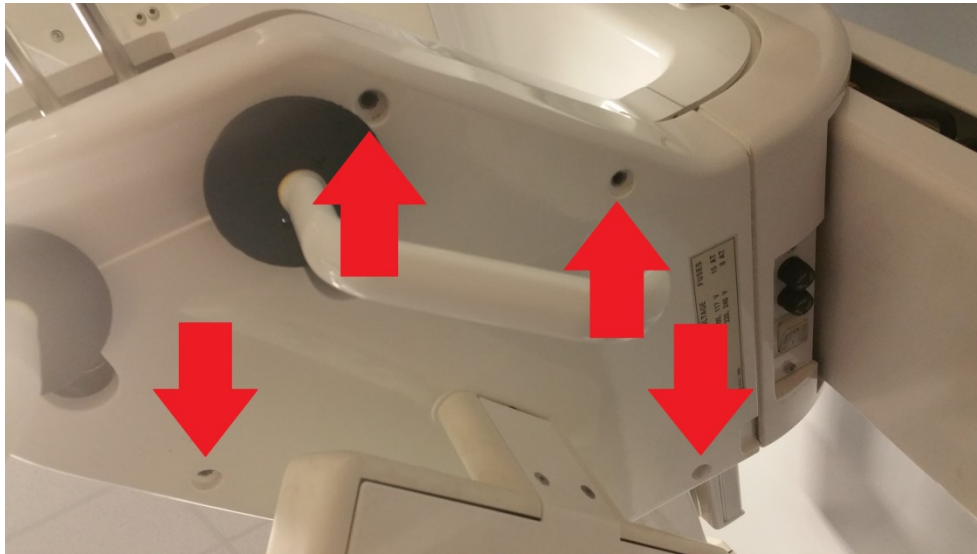

Front column carriage cover



- The front column carriage cover can be detached once the upper cover is detached by pulling from the base of the cover away from the column.

Tube head front cover



- The tube head front cover can be detached by removing the four 3mm Allen screws located on the back of the tube head and pulling from the base of the cover.

Inner cover

- Once the front tube head cover has been removed, the inner cover can be detached by moving the edges of the inner cover by the tube head off the back tube head cover and pulling the inner cover down in front of the collimator.



Back tube head cover

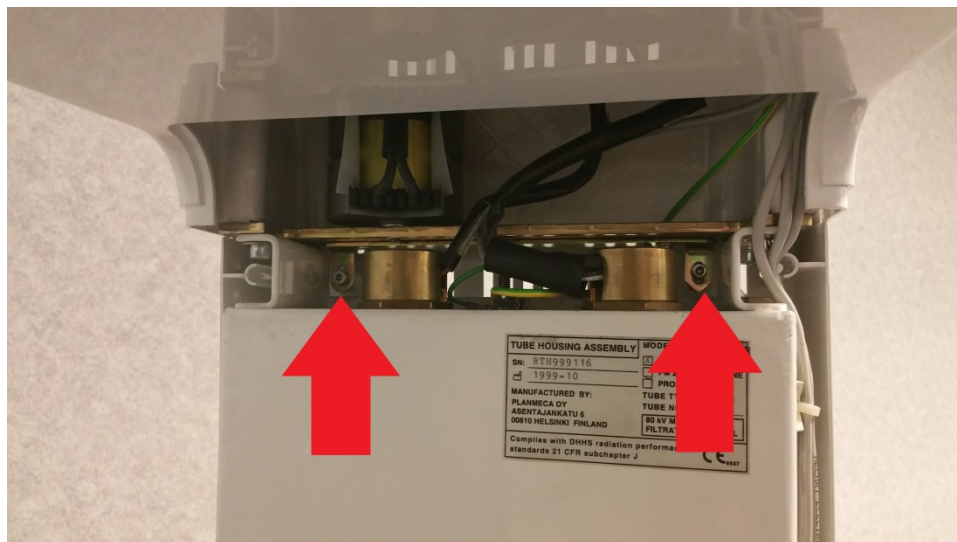

- With the front tube head cover detached, the back tube head cover can be detached by removing the two 3mm Allen screws located on brackets above the tubehead.

Low voltage cover

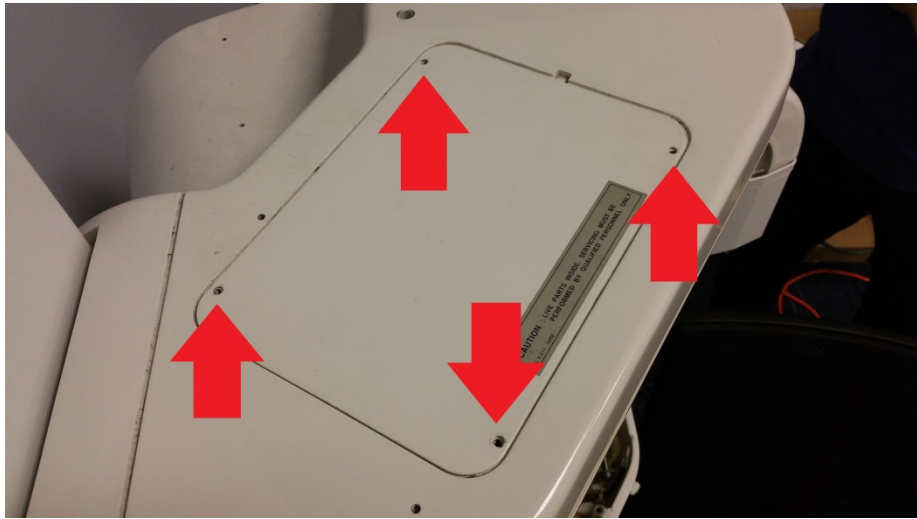

- The low voltage cover is held in by gravity. Slip an Allen under the notch found along the edge of the cover and lift up. ****Do not loosen the four 2.5mm Allen screws. These hold the low voltage board to the cover.**

Quick connect pan sensor holder covers



- The bottom cover plate for pan connector can be detached by removing the 4mm Allen or Torx 30 screw found next to the mirror on the sensor holder.

Quick connect pan sensor holder covers

- With the bottom cover plate for pan connector removed, the side cover for pan connector can be detached by removing the two 3mm Allen screws found up in the sensor holder by both sides along the edges.

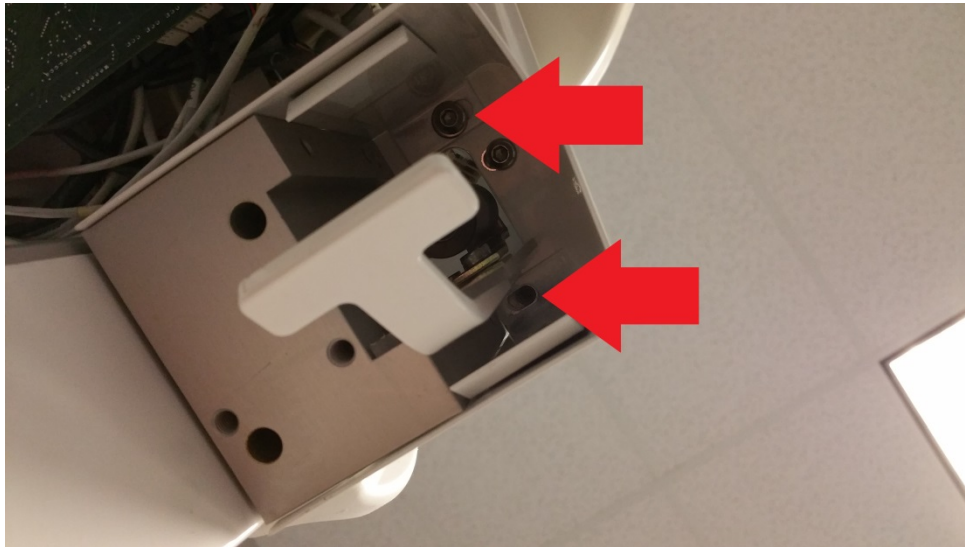

Fixed pan sensor holder for pan only (no sliding)

- Refer to quick connect pan sensor holder covers for the bottom cover plate and side cover.

Fixed pan sensor holder for pan/ceph (sliding)



- The bottom cover plate for pan connector can be detached by removing the 4mm Allen or Torx 30 screw found next to the mirror on the bottom of the sensor holder.

Fixed pan sensor holder for pan/ceph (sliding)

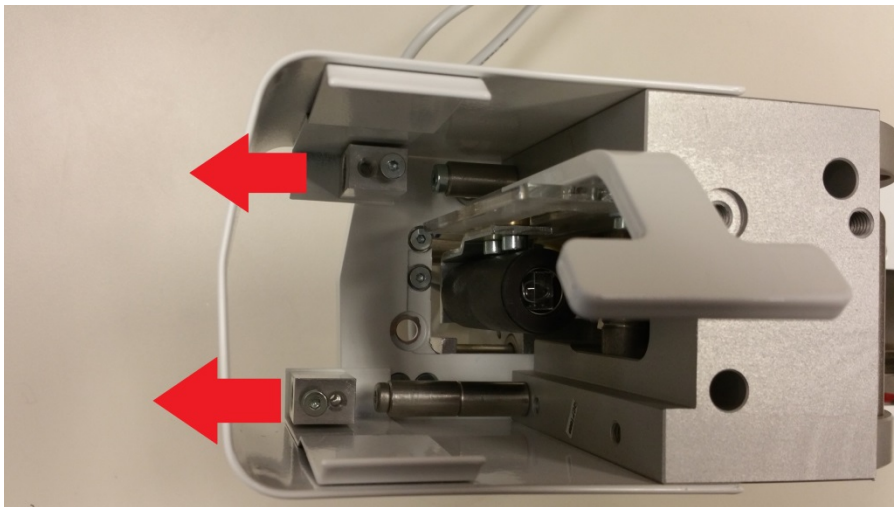
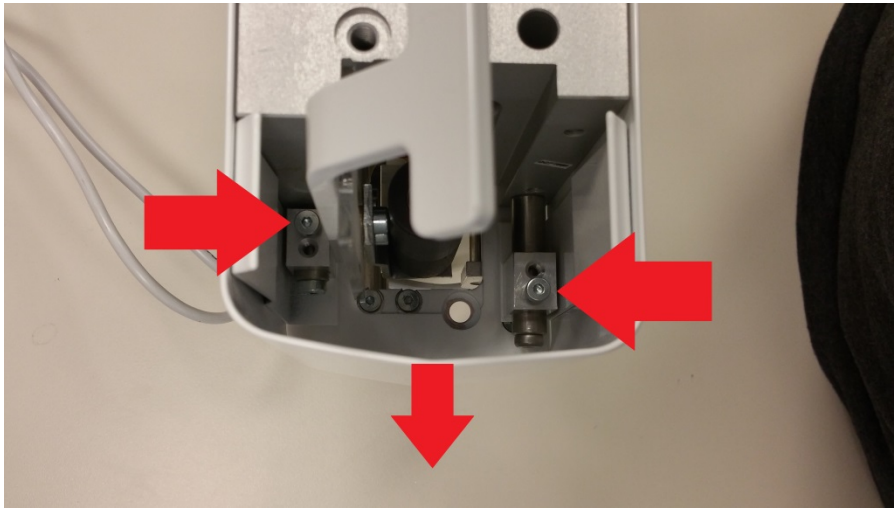

- With the bottom cover plate removed, the side cover can be detached by loosening the two 2.5mm Allen screws located inside the sensor holder, near the top, screwing into square steel blocks. Once these screws are loosened the cover will slide away from the sensor horizontally.

Cephalostat bottom cover

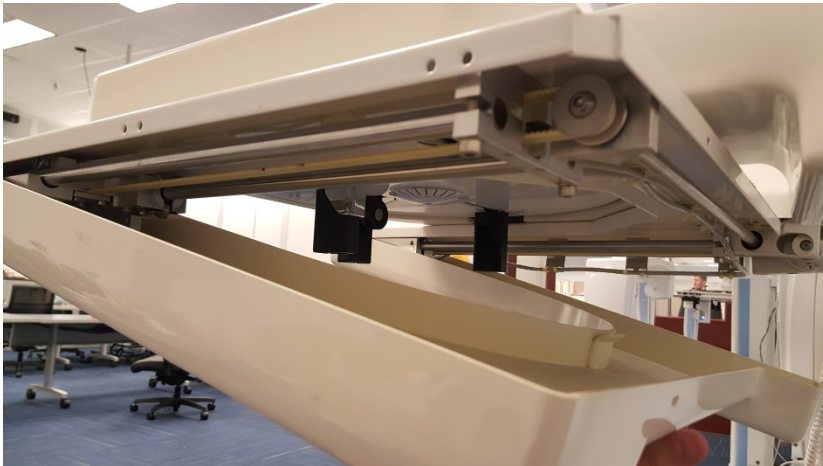
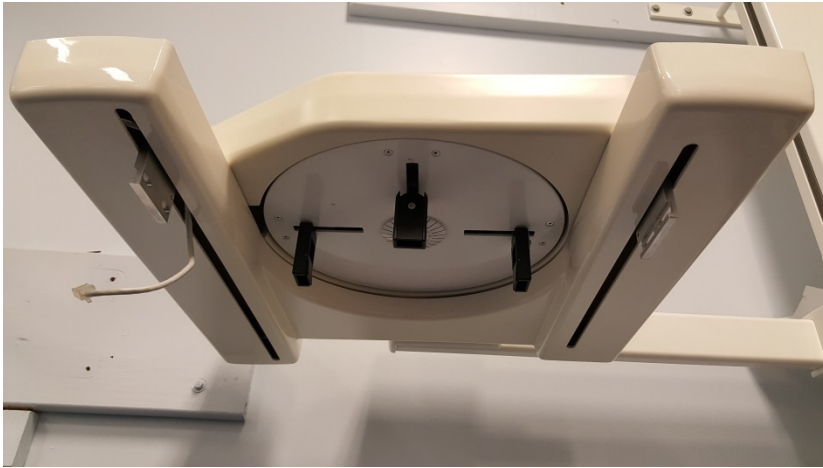

- With the sensor holder and second primary collimator detached, remove the two 2.5mm Allen screws found on the back of the cover. Then lower the back half of cover and slide it away from the wall.

Attachment casting cover



- The attachment casting cover can be detached by removing the two 2.5mm Allen screws located on the top of the cover.

Attachment mechanism cover



- The attachment mechanism cover can be detached by removing the 2.5mm Allen screw located in the middle of the cover.

Cephalostat upper cover

- The cephalostat upper cover can be detached by removing the seven 2.5mm Allen screws located along the edges of the cover.

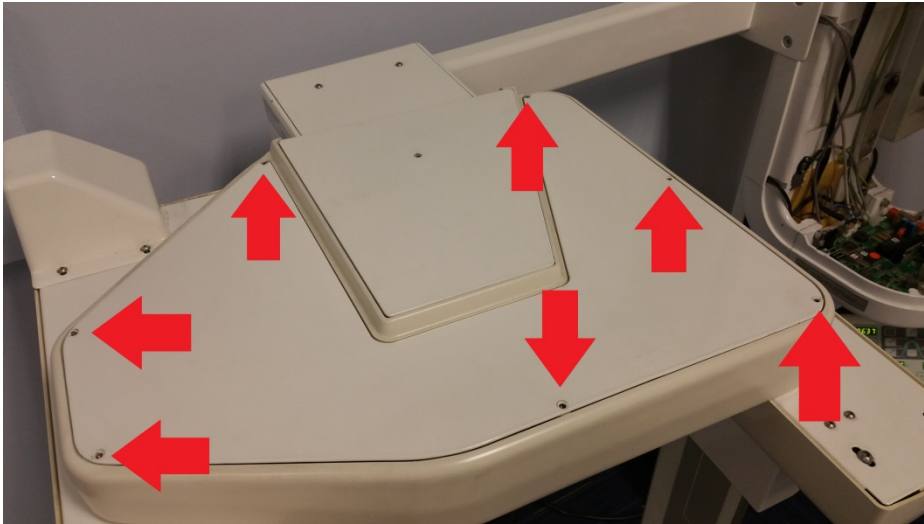

Motor cover

- The motor cover can be detached by removing the two 2.5mm Allen screws located on the front of the cover.

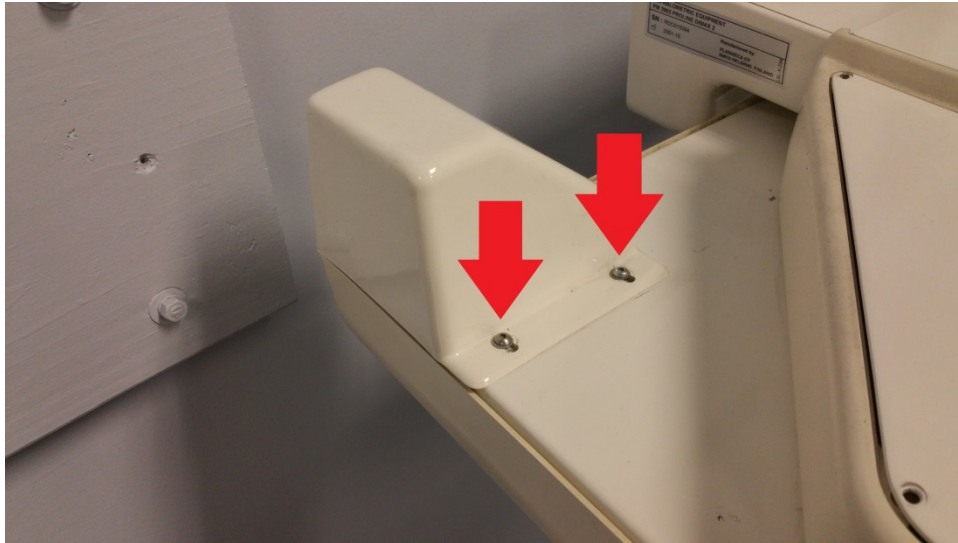

Collimator cover



- The collimator cover can be detached by removing the 4mm Allen screw located on the side of the cover.

Fixed cephalostat sensor covers

- The bottom cover plate can be detached by removing the 4mm Allen or Torx 30 screw located near the edge the cover.



Fixed cephalostat sensor covers



- The ceph side cover can be detached by removing the 4mm Allen screw revealed when the cover plate is detached. Slide the cover horizontally towards the back of the x-ray.

Fixed cephalostat sensor covers

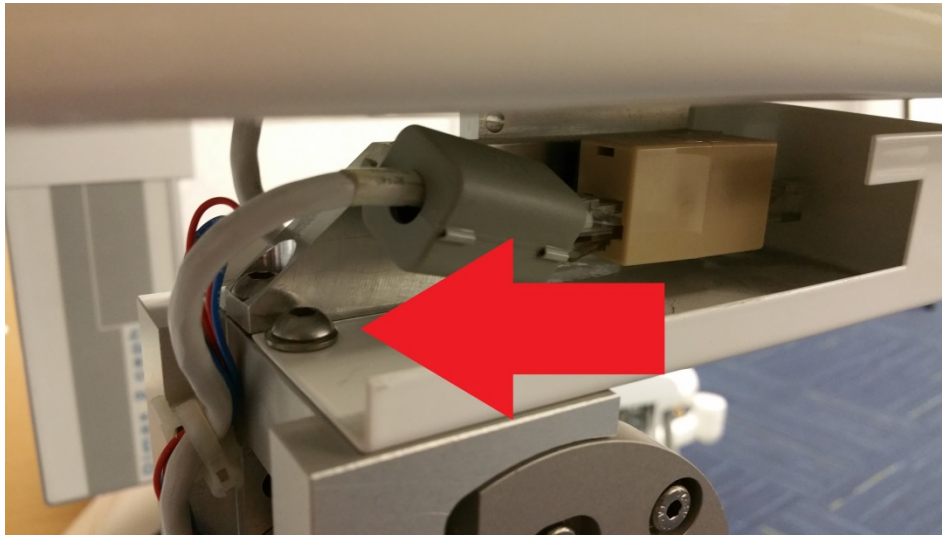

- The cephalostat bottom cover can be detached by removing the 4mm Allen located near the back edge of the cover revealed once the side cover is detached. Slide the cover towards the front of the x-ray.

Fixed cephalostat sensor covers

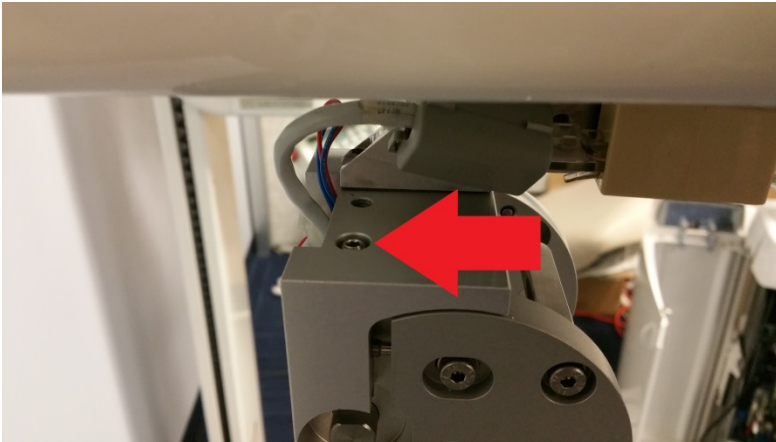

- With the cephalostat bottom cover removed, the locking disc can be detached by fully loosening the two 3mm Allen screws that are recessed in holes directly above the axle rod. Once they are loose, the axle rod can be pushed and the locking disc will move freely.

Quick connect cephalostat sensor covers

- Refer to cephalostat sensor covers (fixed).